

***4322-SYS-NAVAIR***  
**Automated  
Pressure  
Calibrator**  
**Operators Manual**

### **Reproduction and Distribution Notice**

In accordance Section 130 of title 10, United States Code, a DoD Distribution marking system for technical data has been established by DoD Directive 5230.24. IAW this directive and NAVAIR METCAL Policy, the below distribution statement needs to be added to the covers of all Technical Manuals acquired by the NAVAIR METCAL Program:

DISTRIBUTION STATEMENT C. Distribution authorized to U.S. Government Agencies and their contractors for official use or for administrative or operational purposes, determined on **(September 28, 2011)**. Other requests for this document shall be referred to NAVAIR METCAL Program Office, Fleet Support Team Building 1403, 22113 Fortin Circle, Patuxent River, MD 20670-1118

### **About the Product Manual Set**

Product manual set consists of a Model Number 4322 Operators Manual and a Model Number 4322 Service Manual available as Print On Demand documents hosted on the Technical Manual Application System (TMAPS - NATEC's Technical manual master database).

### **System Calibration**

For Navy calibration actions calibrate IAW NA 17-35MTL-3.

# 4322

## Automated Pressure Calibrator

### Operators Manual

*Reproduction and distribution of this technical manual is authorized for U.S. Government purposes.*

## LIMITED WARRANTY AND LIMITATION OF LIABILITY

Each Fluke product is warranted to be free from defects in material and workmanship under normal use and service. The warranty period is one year and begins on the date of shipment. Parts, product repairs, and services are warranted for 90 days. This warranty extends only to the original buyer or end-user customer of a Fluke authorized reseller, and does not apply to fuses, disposable batteries, or to any product which, in Fluke's opinion, has been misused, altered, neglected, contaminated, or damaged by accident or abnormal conditions of operation or handling. Fluke warrants that software will operate substantially in accordance with its functional specifications for 90 days and that it has been properly recorded on non-defective media. Fluke does not warrant that software will be error free or operate without interruption.

Fluke authorized resellers shall extend this warranty on new and unused products to end-user customers only but have no authority to extend a greater or different warranty on behalf of Fluke. Warranty support is available only if product is purchased through a Fluke authorized sales outlet or Buyer has paid the applicable international price. Fluke reserves the right to invoice Buyer for importation costs of repair/replacement parts when product purchased in one country is submitted for repair in another country.

Fluke's warranty obligation is limited, at Fluke's option, to refund of the purchase price, free of charge repair, or replacement of a defective product which is returned to a Fluke authorized service center within the warranty period.

To obtain warranty service, contact your nearest Fluke authorized service center to obtain return authorization information, then send the product to that service center, with a description of the difficulty, postage and insurance prepaid (FOB Destination). Fluke assumes no risk for damage in transit. Following warranty repair, the product will be returned to Buyer, transportation prepaid (FOB Destination). If Fluke determines that failure was caused by neglect, misuse, contamination, alteration, accident, or abnormal condition of operation or handling, including overvoltage failures caused by use outside the product's specified rating, or normal wear and tear of mechanical components, Fluke will provide an estimate of repair costs and obtain authorization before commencing the work. Following repair, the product will be returned to the Buyer transportation prepaid and the Buyer will be billed for the repair and return transportation charges (FOB Shipping Point).

THIS WARRANTY IS BUYER'S SOLE AND EXCLUSIVE REMEDY AND IS IN LIEU OF ALL OTHER WARRANTIES, EXPRESS OR IMPLIED, INCLUDING BUT NOT LIMITED TO ANY IMPLIED WARRANTY OF MERCHANTABILITY OR FITNESS FOR A PARTICULAR PURPOSE. FLUKE SHALL NOT BE LIABLE FOR ANY SPECIAL, INDIRECT, INCIDENTAL, OR CONSEQUENTIAL DAMAGES OR LOSSES, INCLUDING LOSS OF DATA, ARISING FROM ANY CAUSE OR THEORY.

Since some countries or states do not allow limitation of the term of an implied warranty, or exclusion or limitation of incidental or consequential damages, the limitations and exclusions of this warranty may not apply to every buyer. If any provision of this Warranty is held invalid or unenforceable by a court or other decision-maker of competent jurisdiction, such holding will not affect the validity or enforceability of any other provision.

Fluke Corporation  
P.O. Box 9090  
Everett, WA 98206-9090  
U.S.A.

Fluke Europe B.V.  
P.O. Box 1186  
5602 BD Eindhoven  
The Netherlands



# Table of Contents

Chapter	Title	Page
<b>1</b>	<b>Product Overview and Specifications .....</b>	<b>1-1</b>
	Introduction.....	1-3
	Product Overview .....	1-3
	Safety Information .....	1-4
	The Product Manual Set .....	1-5
	Unpacking.....	1-5
	Controller Indicators and Controls.....	1-6
	Handheld Control Indicators and Controls .....	1-10
	Pressure Intensifier Indicators and Controls .....	1-12
	Accessory Kit Items.....	1-14
	General Specifications .....	1-17
	Pressure Limits .....	1-18
	Measurement Specifications .....	1-20
	Pressure Control Specifications .....	1-21
	Pressure Switch Testing Specifications (Handheld).....	1-21
<b>2</b>	<b>Setup .....</b>	<b>2-1</b>
	Introduction.....	2-3
	Quick-Connector Fittings .....	2-3
	Configure the Pressure Supply.....	2-4
	Controller Only.....	2-4
	Controller and Nitrogen Cylinder.....	2-5
	Controller and Intensifier .....	2-5
	Internal and External Supply Setting.....	2-6
	Contamination Prevention .....	2-8
	Install the CPS .....	2-9
	Remove the CPS.....	2-10
	Connect the Handheld Control Accessory.....	2-10
	Connect to a Unit Under Test (UUT) .....	2-11
	Make a Head-Height Correction.....	2-14
	Controller Settings .....	2-15
	The Settings Menu.....	2-15
	Security Levels .....	2-20
	Sounds and Alarm Volume.....	2-21

<b>3</b>	<b>Controller Operation .....</b>	<b>3-1</b>
	Introduction.....	3-3
	Turn On the Controller .....	3-3
	Operating Modes.....	3-3
	Warm-up .....	3-3
	Common Navigation Buttons .....	3-4
	The Main Menu .....	3-4
	Set and Control Pressure.....	3-6
	Set Target Pressure .....	3-8
	Interrupt Pressure Control .....	3-8
	Pressure Control Modes .....	3-8
	Dynamic Control Mode.....	3-9
	Dynamic Control Mode with Jog Approach .....	3-10
	Static Control Mode .....	3-11
	Set the Pressure Limits and Control Limits.....	3-12
	Pressure Limits (Upper and Lower) .....	3-12
	Control Limits (Hold and Stability) .....	3-13
	Pressure Control Functions.....	3-14
	Jog Step Pressure Up or Down.....	3-14
	Vent the Controller.....	3-15
	Abort for Emergency Pressure Relief .....	3-15
	Measurement Settings and Limits.....	3-16
	CalCheck Function .....	3-16
	AutoZero and BaroCheck.....	3-16
	Measurement Indicator .....	3-18
	Measurement Modes .....	3-18
	Measurement Resolution .....	3-19
	Unit of Measure .....	3-20
	UUT Tolerance Limit .....	3-22
	Controller Tools.....	3-22
	System Purge .....	3-22
	Hose Purge.....	3-23
	Leak Test .....	3-24
	Exercise .....	3-25
	Test a UUT.....	3-26
	The Test Menu.....	3-27
	Test Sequences .....	3-28
	Test Sequence Actions .....	3-28
	Find a Saved Test .....	3-29
	Edit a Test .....	3-29
	Copy a Test .....	3-29
	Delete a Test.....	3-29
	Make a New Gauge/Transducer Test.....	3-30
	Make a New Pressure Switch Test.....	3-33
	Run a Test Sequence .....	3-35
	View Test Results .....	3-37
	Print a Test Report.....	3-38
<b>4</b>	<b>Intensifier Operation .....</b>	<b>4-1</b>
	Introduction.....	4-3
	Turn On the Intensifier .....	4-3
	Choose a Boost Pressure.....	4-3
	Set Boost Pressure .....	4-4
	Vent the System .....	4-5

	Isolate Pressure .....	4-5
<b>5</b>	<b>Remote Operation .....</b>	<b>5-1</b>
	Introduction.....	5-3
	USB Remote Interface Setup.....	5-4
	IEEE-488 (GPIB 488.2) Remote Interface Setup.....	5-4
	Remote Operation Commands.....	5-4
	Limitations of Using Remote Commands .....	5-4
	Overview of Command Structures .....	5-5
	Alphabetical List of Remote Commands.....	5-6
	Remote Command Format .....	5-8
	Common and Status Commands.....	5-9
	Specific Commands.....	5-10
	488.2 Status System.....	5-19
	Status Byte Register .....	5-20
	Standard Event Register .....	5-22
	Ready Status Register.....	5-22
	Operation Status Register.....	5-23
	Remote Errors.....	5-23
<b>6</b>	<b>Operator Maintenance and Troubleshooting.....</b>	<b>6-1</b>
	Introduction.....	6-3
	Fuse Replacement.....	6-3
	Clean the Front Panels and Cases .....	6-5
	Controller Identification .....	6-5
	Controller Event Log.....	6-5
	Reset Controller Settings .....	6-6
	Nitrogen Cylinder Maintenance.....	6-6
	Safety.....	6-6
	Visual Inspection.....	6-7
	External Cylinder Cleaning Procedure.....	6-7
	Internal Cylinder Cleaning Procedure.....	6-8
	Nitrogen Recharge Procedure.....	6-9
	Controller Troubleshooting.....	6-11
	Controller Fault Codes .....	6-11
	Electrical Problems.....	6-13
	Pressure Generation and Indication Problems.....	6-13
	CPS and Quick-Connect Problems.....	6-14
	Intensifier Troubleshooting.....	6-14
	Electrical Problems.....	6-14
	Pressure Selection and LED Indications .....	6-15
	Abnormal Noises.....	6-15
	Pressure Generation and Indication Problems.....	6-16
	Valves and Quick-Connect Problems.....	6-16
<b>7</b>	<b>Self-Calibration Procedure .....</b>	<b>7-1</b>
	Introduction.....	7-3
	Fundamentals.....	7-3
	Required Equipment .....	7-4
	Environmental Conditions .....	7-4
	Equipment Setup.....	7-5
	Preliminary Operations .....	7-5
	Module Calibration Procedure.....	7-7
	Module Alignment Procedure.....	7-9



# List of Tables

Table	Title	Page
1-1.	Symbols.....	1-4
1-2.	Controller Indicators and Controls.....	1-6
1-3.	Control Pad.....	1-8
1-4.	Handheld Control Keys and Functions .....	1-10
1-5.	Intensifier Controls and Indicators.....	1-12
1-6.	Accessories.....	1-14
1-7.	Accessories - Adaptor Kit .....	1-16
1-8.	Accessories - Spares Kit (Not Shown).....	1-17
2-1.	Settings Menu.....	2-16
2-2.	Security Levels.....	2-20
2-3.	Security Level Diagram .....	2-20
2-4.	Sounds.....	2-21
2-5.	Alarms.....	2-21
3-1.	Navigation buttons .....	3-4
3-2.	Main Run Screen.....	3-4
3-3.	Hold limits.....	3-13
3-4.	Stability Limits.....	3-13
3-5.	Jog Step Parameters .....	3-15
3-6.	Pressure Status Indicator .....	3-18
3-7.	Units of Measure .....	3-20
3-8.	Leak Test Parameters .....	3-25
3-9.	Exercise Menu.....	3-26
3-10.	Test Menu.....	3-27
3-11.	Edit Test Menu .....	3-31
3-12.	Test Results Menu .....	3-37
5-1.	Power and Remote Interface Panel .....	5-3
5-2.	List of Alphabetical Commands.....	5-6
5-3.	Error Values .....	5-24
6-1.	Fuse .....	6-3
6-2.	Intensifier Fuse.....	6-3
6-3.	Reset Functions .....	6-6
7-1.	Calibration Equipment .....	7-4



# List of Figures

Figure	Title	Page
1-1.	The 4322 Portable Automated Pressure Calibrator.....	1-3
2-1.	Quick-Connector Operation Example.....	2-3
2-2.	Pressure Supply Configurations.....	2-4
2-3.	Automatic Supply Switch Example.....	2-7
2-4.	Automatic Supply Switch Example.....	2-7
2-5.	The CPS.....	2-8
2-6.	CPS Configurations.....	2-9
2-7.	CPS Installation and Removal.....	2-10
2-8.	Handheld Control Connection.....	2-11
2-9.	UUT Connection Example.....	2-12
2-10.	Pressure Switch Lead Connections.....	2-13
2-11.	Head-Height Correction Example.....	2-14
2-12.	Head Menu.....	2-15
2-13.	Sound Menu.....	2-22
3-1.	Startup Screen Example.....	3-3
3-2.	Pressure Transducer Modules and Barometer Removal.....	3-7
3-3.	Set Target Pressure.....	3-8
3-4.	Control Mode Settings.....	3-9
3-5.	Dynamic Pressure Control Mode Example.....	3-10
3-6.	Jog To Approach.....	3-10
3-7.	Dynamic Control Mode with Jog Approach Example.....	3-11
3-8.	Static Pressure Control Mode Example.....	3-11
3-9.	Pressure Limits.....	3-12
3-10.	Control Limits.....	3-14
3-11.	CalCheck Indicator.....	3-16
3-12.	Measurement Mode Settings.....	3-19
3-13.	Unit of Measure.....	3-21
3-14.	Hose Purge Configuration.....	3-24
3-15.	Visual Leak Detection.....	3-25
3-16.	Test Name Convention.....	3-28
3-17.	Gauge/Transducer and Switch New Test Menus.....	3-30
5-1.	Status Register.....	5-20
6-1.	Fuse Replacement.....	6-4
6-2.	Nitrogen Fill Adapter.....	6-10
7-1.	Equipment Setup.....	7-5

7-2.	Module Selection .....	7-7
7-3.	Calibration Menu Configuration .....	7-8
7-4.	Module Selection .....	7-9
7-5.	Alignment Menu Configuration .....	7-10



# **Chapter 1**

## ***Product Overview and Specifications***

<b>Title</b>	<b>Page</b>
Introduction.....	1-3
Product Overview .....	1-3
Safety Information .....	1-4
The Product Manual Set .....	1-5
Unpacking.....	1-5
Controller Indicators and Controls.....	1-6
Handheld Control Indicators and Controls .....	1-10
Pressure Intensifier Indicators and Controls .....	1-12
Accessory Kit Items.....	1-14
General Specifications .....	1-18
Pressure Limits .....	1-19
Measurement Specifications .....	1-20
Pressure Control Specifications .....	1-20
Pressure Switch Testing Specifications (Handheld).....	1-21



## Introduction

This chapter supplies information about the Product, the manual set, safety information, contact information, and specifications.

## Product Overview

The Fluke 4322 Automated Pressure Calibrator (the Product or Calibrator) is a transportable system including an automated controller for calibration and testing of pressure measurement instruments (see Figure 1-1). The Calibrator can be used to calibrate and test analog gauges, digital gauges, pressure transducers, pressure switches, and other pressure devices.

For maximum versatility and portability, the Calibrator consists of a Pressure Controller (the Controller), a Pressure Intensifier (the Intensifier), a Nitrogen Cylinder, and an Accessory Kit that can be used in three different configurations. Determination of which configuration to use depends on how much pressure is necessary to complete the calibration (see “Calibrator Configurations” in Chapter 2).

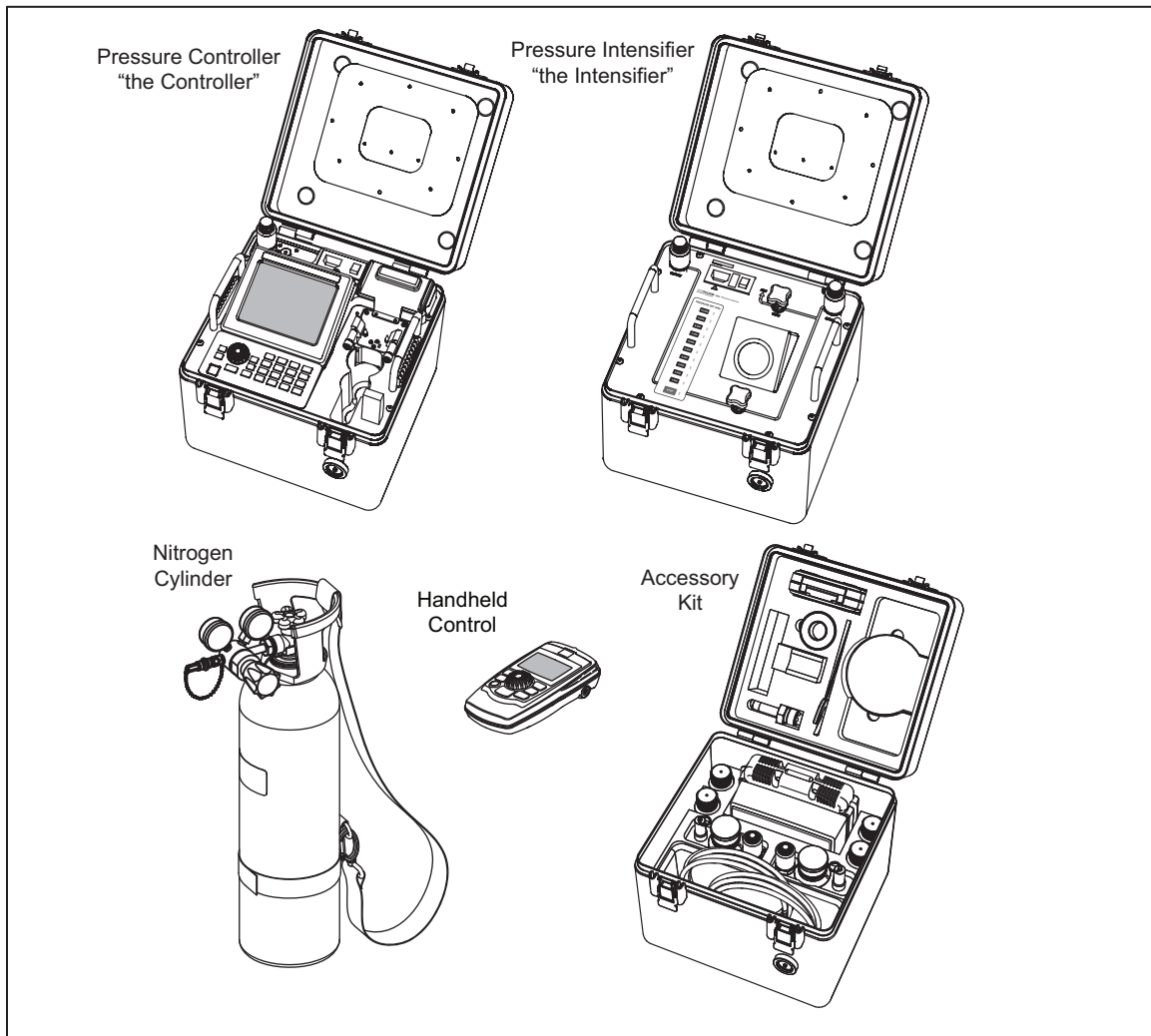









Figure 1-1. Main Components of 4322-SYS-NAVAIR Configuration of 4322 Automated Pressure Calibrator

## Safety Information

A **Warning** identifies condition and procedures that are dangerous to the user. A **Caution** identifies conditions and procedures that can cause damage to the Product or the equipment under test.

See Table 1-1 for a list of symbols used in this manual and on the Calibrator.

Table 1-1. Symbols

Symbol	Description	Symbol	Description
	Risk of Danger. Important information. See manual.		Conforms to relevant North American Safety Standards.
	Conforms to European Union directives		Do not dispose of this product as unsorted municipal waste. Go to Fluke's website for recycling information.
	Earth ground		Hazardous voltage
	Conforms to relevant Australian EMC requirements		

### Warning

To prevent possible electrical shock, fire, or personal injury:

- High pressure liquids and gases are potentially hazardous. Energy stored in these liquids and gases can be released unexpectedly and with extreme force. High pressure systems should be assembled and operated only by personnel who have been instructed in proper safety practices.
- Read all safety Information before you use the Product.
- Carefully read all instructions.
- Use the Product only as specified, or the protection supplied by the Product can be compromised.
- Examine the case before you use the Product. Look for cracks or missing plastic. Carefully look at the insulation around the terminals.
- Do not use the Product if it operates incorrectly.
- Do not use and disable the Product if it is damaged.
- Use only the mains power cord and connector approved for the voltage and plug configuration in your country and rated for the Product.
- Replace the mains power cord if the insulation is damaged or if the insulation shows signs of wear.
- Make sure the ground conductor in the mains power cord is connected to a protective earth ground. Disruption of the protective earth could put voltage on the chassis that could cause death.

- Before using this equipment to generate or apply pressure, ensure integrity of all components to be pressurized and that they are rated to adequate working pressure.
- Do not put the Product where access to the mains power cord is blocked.
- Do not use test leads if they are damaged. Examine the test leads for damaged insulation and measure a known voltage.
- Do not exceed the Measurement Category (CAT) rating of the lowest rated individual component of a Product, probe, or accessory.
- Keep fingers behind the finger guards on the probes.
- Do not apply more than the rated voltage, between the terminals or between each terminal and earth ground.
- Do not touch voltages > 30 V ac rms, 42 V ac peak, or 60 V dc.
- Do not use the Product around explosive gas.

## **The Product Manual Set**

The Calibrator includes an Operators Manual and a Service Manual. Both manuals are online at [www.flukecal.com](http://www.flukecal.com) and on a CD in the Accessory Kit.

### *Note*

*Not all available components are included in every configuration of a 4322 system. Both manuals assume model 4322-SYS-NAVAIR, which includes all major components available, except for the 4322-REM Handheld Control, which is ordered separately.*

- This *4322 Operators Manual* contains basic system and feature information, operation instructions, and basic user maintenance and troubleshooting information.
- The *4322 Service Manual* contains service, calibration, and repair information and instructions.

## **Unpacking**

The Calibrator comes in three shipment boxes. The Nitrogen Cylinder comes uncharged and must be assembled and charged with dry-nitrogen. See Chapter 6 for instructions.

## Controller Indicators and Controls

The Pressure Controller (the Controller) shown in Table 1-2, is an electronic pressure controller that precisely sets, controls, and measures pressure.

Table 1-2 shows the items on the front panel along with a brief description.

**Table 1-2. Controller Indicators and Controls**

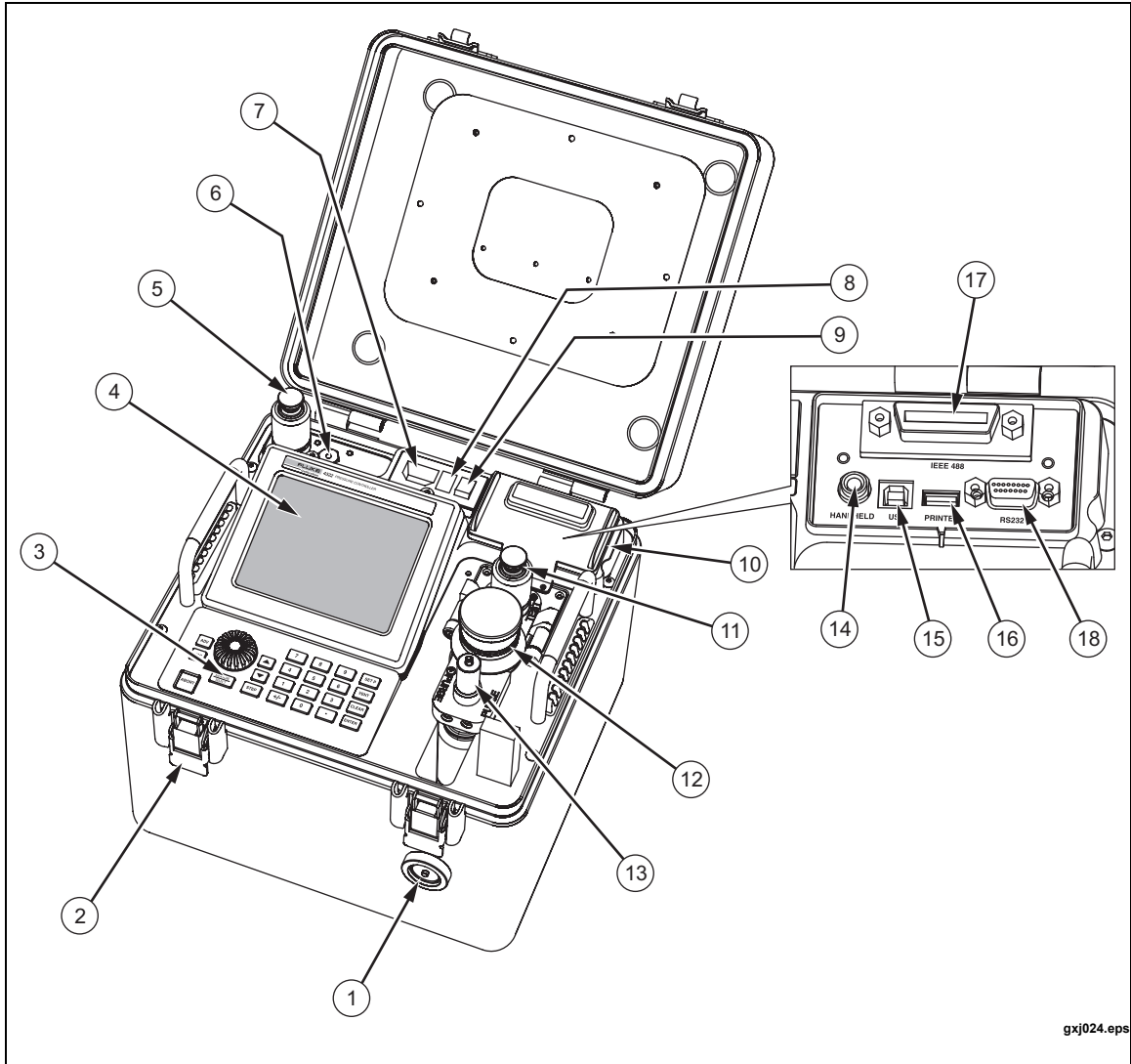

Item	Name	Function
①	Case Pressure Equalization Valve	Push to equalize the pressure inside the case to the pressure outside of the case. If the pressure is not equal, the case is difficult to open because it is sealed.
②	Spring-Loaded Case Latches	Spring-loaded latches to keep the lid closed and sealed.

**Table 1-2. Controller Indicators and Controls (cont.)**



Item	Name	Function
③	Control Panel	Control panel with 23 keys and a dual-purpose, push button/rotary dial to navigate and control the user interface. See Table 1-3.
④	Display	5-inch color LCD screen.
⑤	SUPPLY Port	Female quick connect (QC) supply port that connects to the accessory Nitrogen Cylinder, Pressure Intensifier, or external nitrogen pressure supply. Maximum allowable supply pressure is 10,000 psig. <b>⚠ Warning</b> <b>To prevent injury, the supply must be shut-off and depressurized to remove the male supply line connector from the supply port.</b>
⑥	ATM (Atmosphere Vent)	Vent used by the barometer to measure atmospheric pressure.
⑦	Input Power Cord Connector	Input connector for the supplied power cord. The power entry module and power cord are a standard appliance inlet, IEC/EN 60320-1/C14, with a vertical three-prong arrangement.
⑧	Fuse	Electrical fuse that protects the system from overcurrent. For fuse replacement instructions, see Chapter 6.
⑨	Power Switch	Electrical power switch to turn on and turn off the unit.
⑩	Communications Module	Contains all external communication interfaces. See items ⑭, ⑮, ⑯, ⑰, and ⑱.
⑪	TEST Port	Female quick connect (QC) test port that connects to the UUT. <b>⚠ Warning</b> <b>To prevent injury, the supply must be shut-off and depressurized to remove the female UUT line connector from the supply port.</b>
⑫	Contamination Prevention System (CPS)	Removable and serviceable component that protects the Controller from contaminates in the UUT. See “About UUT Cross-Contamination Prevention” in Chapter 2.
⑬	HOSE PURGE Port	Male quick connect (QC) inlet port to purge a hose. See “Hose Purge” in Chapter 3.
⑭	Handheld Control Port	Handheld Control interface. See “Handheld Control Indicators and Controls” on page 1-10.
⑮	USB	USB 2.0 remote operation interface. See Chapter 5, “Remote Operation”.
⑯	Printer	USB 2.0 USB printer interface used to print test calibration reports (see “Print a Test Report” in Chapter 3). <i>Note</i> <i>The printer must be PCL-5 compatible.</i>
⑰	GPIB	IEEE-488.2 remote operation interface. See Chapter 5, “Remote Operation”.
⑱	RS-232 Port	Used by Fluke Calibration for diagnostic testing.

The control panel has 23 keys and a dual-purpose, push button/rotary dial to navigate and control the user interface. After a test is started, the keys are used to control and adjust the parameters of the test in progress. Table 1-3 shows the keys on the control panel along with an explanation of the key functions.

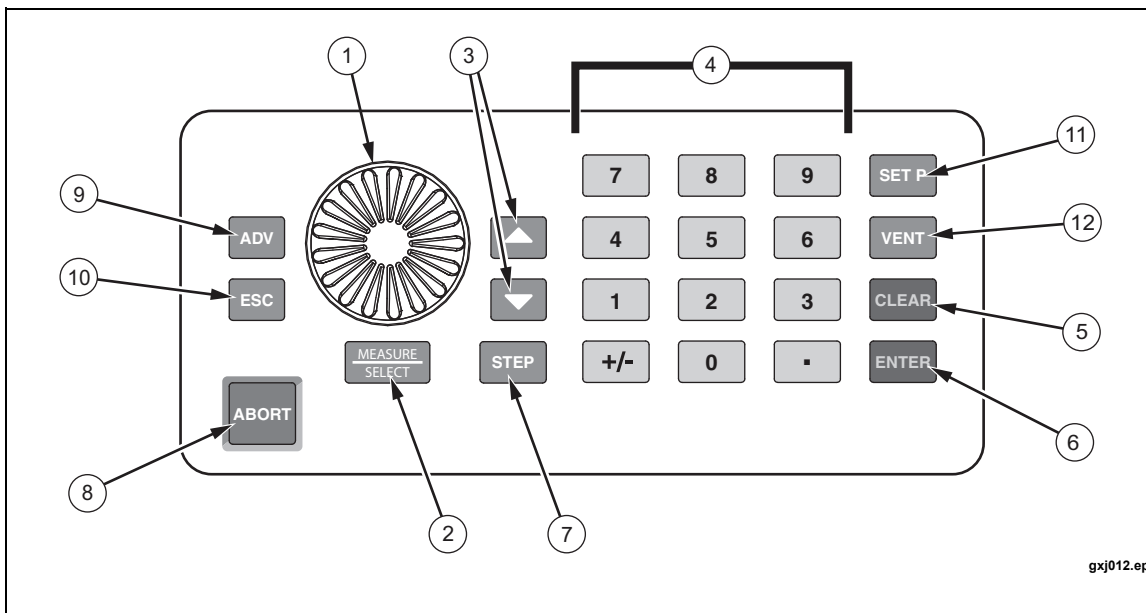
**Table 1-3. Control-Panel Keys and Functions**



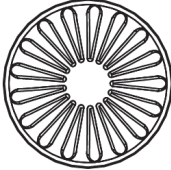









gxj012.eps

Item	Key	Key Function: Menu Navigation and Test Configuration	Key Function: Test in Progress
①		Turn to cycle through the on-screen fields. Push to open the selected menu or set the selected value in the highlighted field.	Turn to increase or decrease the applied pressure. The faster the dial is turned, the faster the pressure changes. Push to set the numerical entry value in the highlighted field.
②		Opens the selected menu or sets the selected value in the highlighted field.	Sets the numerical entry value in the highlighted field.



**Table 1-3. Control-Panel Keys and Functions (cont.)**

Item	Key	Key Function: Menu Navigation and Test Configuration	Key Function: Test in Progress
③	 	Cycles through the on-screen fields.	Increases or decreases applied pressure. The longer a key is pushed, the faster the pressure increases or decreases.
④		Enter numerical values.	Enter numerical values.
⑤		Clears the numerical value from the highlighted field.	Clears the numerical value from the highlighted field.
⑥		Sets the numerical entry value in the highlighted field.	Sets the numerical entry value in the highlighted field.
⑦		Cancels the current action and closes the active menu.	Stops pressure control and pauses the test. To continue the test, push ESC again.
⑧		No functionality.	Aborts (stops) the test and quickly vents the applied pressure to atmosphere.
⑨		No functionality.	Advance to the subsequent test step or pressure point.
⑩		Changes the Jog Step between Coarse and Fine.	Changes the Jog Step between Coarse and Fine.
⑪		Opens the target pressure configuration menu.	No functionality.
⑫		No functionality.	<p>Stops the test and displays a confirmation prompt to vent.</p> <p>If “Confirm” is selected, the Controller vents the applied pressure to atmosphere. If the user selects “Cancel” on the prompt, the Controller closes the prompt and the test resumes.</p> <p>If a target pressure is set and the Vent key is pushed, the Controller immediately vents pressure to atmosphere without a prompt.</p>

## Handheld Control Indicators and Controls

The Handheld Control (the Handheld) has seven keys and a dual-purpose, push button/rotary dial to navigate and control the user interface (see Table 1-4). The Handheld has a display that shows information such as test settings and pressure settings. The keys on the Handheld allow for direct test control of the test in progress. When the Handheld is connected to the Controller, all of the keys on the Controller are disabled with the exception of the Abort key. Table 1-4 shows the keys on the Handheld along with an explanation of their functions.

*Note*

*The Handheld is an independent test control device that controls basic test functions to complete a test. When the Handheld is in use, the user interface on the Controller is disabled and blocked by a dialog box. Disconnect the Handheld when the test is finished to resume normal Controller operation.*

**Table 1-4. Handheld Control Keys and Functions**

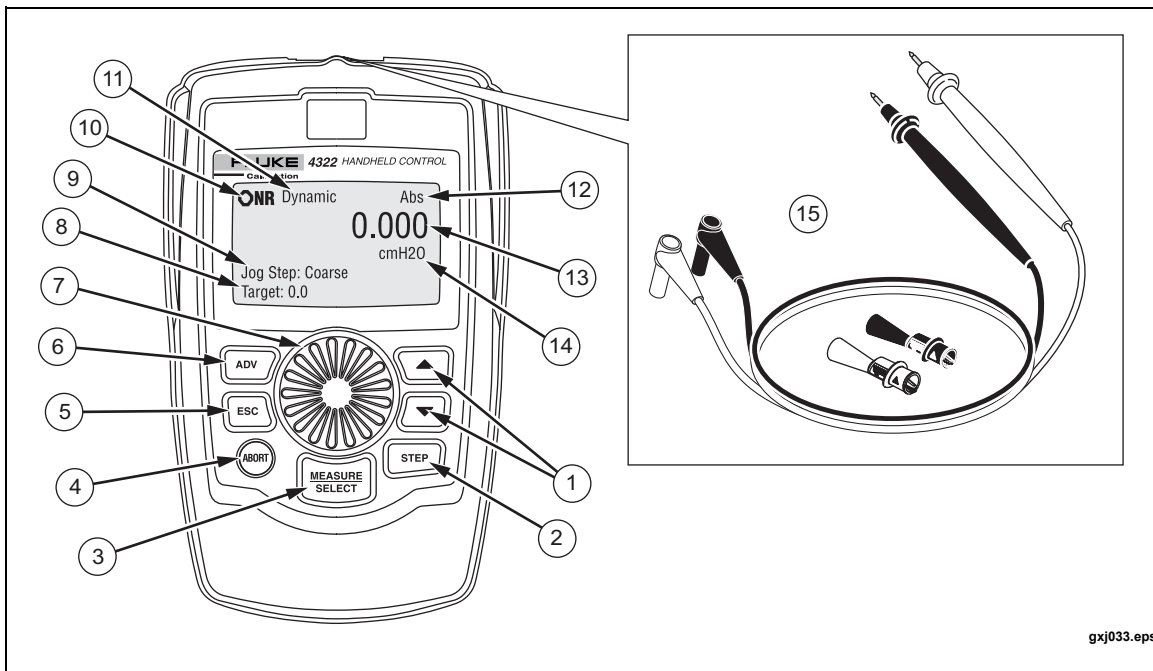

gxj033.eps







Item	Key	Key Function: Menu Navigation and Test Configuration	Key Function: Test in Progress
①		Cycles through the on-screen fields or increases or decreases the numerical value in the highlighted field.	Push to increase or decrease applied pressure. The longer a key is pushed, the faster the pressure will increase or decrease.
②		Changes the Jog Step between Coarse and Fine.	Changes the Jog Step between Coarse and Fine.

Table 1-4. Handheld Control Keys and Functions (cont.)

Item	Key	Key Function: Menu Navigation and Test Configuration	Key Function: Test in Progress
③		Select	Opens the selected menu or set the selected value in the highlighted field.
④		No functionality.	Aborts (stops) the test and quickly vents the applied pressure to atmosphere.
⑤		Cancels the current action and closes the active menu.	Stops pressure control and pauses the test. To continue the test, push ESC again.
⑥		No functionality.	Advance to the subsequent test step or pressure point.
⑦		Turn to cycle through the on-screen fields. Push to open the selected menu or set the selected value in the highlighted field.	Turn to increase or decrease the applied pressure. The faster the dial is turned, the faster the pressure changes. Push to set the numerical entry value in the highlighted field.
Item	Display Item	Description	
⑧	Target Pressure	Shows the current target pressure value.	
⑨	Jog Step	Shows the Jog Step setting. The two Jog Step settings are Coarse and Fine. Refer to “Jog Step Pressure Up or Down” in Chapter 3.	
⑩	Measurement Indicator	Shows the measurement indicator. See “Measurement Indicators” in Chapter 3.	
⑪	Pressure Control Mode	Shows the active control mode. The indications are <b>Dynamic</b> and <b>Static</b> . When pressure control is active, the indicators are animated. See “Pressure Control Modes” in Chapter 3.	
⑫	Measurement Mode	Shows the active measurement mode. See “Measurement Modes” in Chapter 3.	
⑬	Measured Pressure	Shows the current applied pressure to the UUT.	
⑭	Unit of Measure	Shows the unit of measure.	
⑮	Continuity Leads and Jacks	Positive (red) and negative (black) leads and jacks to connect the accessory continuity leads.	

## Pressure Intensifier Indicators and Controls

The Pressure Intensifier (the Intensifier) shown in Table 1-5 is an electric pressure booster system that can boost gas pressure supply from (500 to 3,000) psig up to 10,000 psig. Table 1-5 shows the items on the front panel along with a brief description.

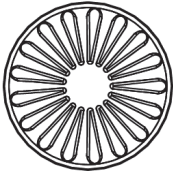
Table 1-5. Intensifier Controls and Indicators

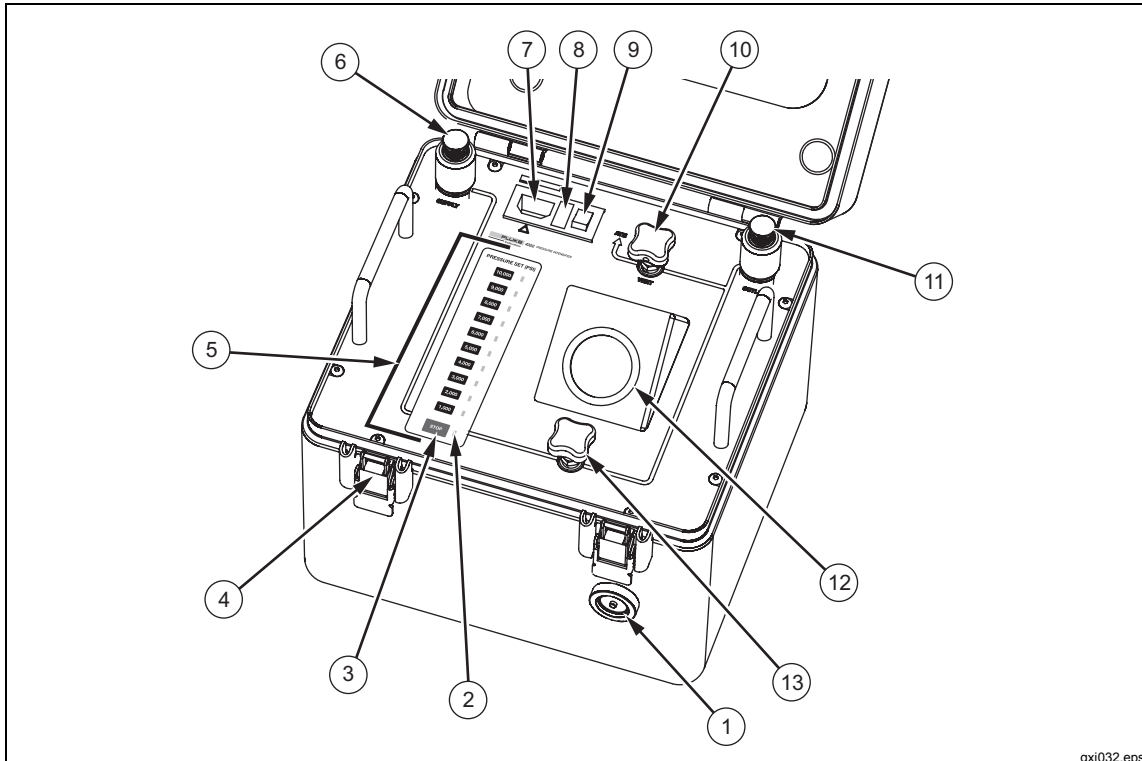

gxj032.eps

Item	Name	Function
①	Case Pressure Equalization Valve	Push to equalize the pressure inside the case to the pressure outside of the case. If the pressure is not equal, the case is difficult to open because it is sealed.
②	Status LEDs	Shows the selected target pressure and also shows error conditions and problems with the system. When the system is on and no pressure is selected, the STOP key LED is illuminated (the system is on and ready). The STOP key LED extinguishes when a target pressure is selected. When a target pressure is selected, the status LED to the right of the key illuminates. The LED stays illuminated until <b>STOP</b> is pushed or an error occurs. System error conditions are shown by flashing LEDs. See Chapter 6 for troubleshooting information.
③	<b>STOP</b>	Single push button that stops the production of boost pressure and cancels the pressure selection. Use the Vent Valve to release boost pressure at a higher rate.  <b>⚠ Caution</b> <b>To prevent Controller contamination, do not open the Intensifier Vent Valve while the Controller is actively controlling pressure.</b>

**Table 1-5. Intensifier Controls and Indicators (cont.)**

Item	Name	Function
④	Spring-Loaded Case Latches	Spring-loaded latches used to keep the lid closed and sealed.
⑤	Intensifier Pressure Selection Keys (PRESSURE SET PSI)	Keypad used to select the Intensifier pressure. Keypad selections are in 1,000 psig increments that range from 1,000 psig to 10,000 psig. Each key is has a status LED indicator that visually shows the selected boost pressure and system status (see ②).
⑥	SUPPLY Port	Female quick connect (QC) supply port that connects to the accessory Nitrogen Cylinder or external nitrogen pressure supply. Supply must be between (500 to 3,000) psig.  <b>⚠Warning</b> <b>To prevent injury, the supply must be shut off and depressurized to remove the male supply line connector from the supply port.</b>
⑦	Input Power Cord Connector	Input connector for the supplied power cord. The power entry module and power cord are a standard appliance inlet (IEC/EN 60320-1/C14) with a vertical three-prong arrangement.
⑧	Fuse	Electrical fuse that protects the system from overcurrent. For fuse replacement instructions, refer to “Fuse Replacement” in Chapter 6.
⑨	Power Switch	Electrical power switch to turn on and turn off the unit.
⑩	Vent Valve (VENT)	Needle valve to manually discharge system pressure to atmosphere.  <i>Note</i> <i>Source pressure can be depleted very quickly if it is not turned off before venting the system.</i>
⑪	OUTLET Port	Female quick connect (QC) outlet port that connects the Controller.  <b>⚠Warning</b> <b>To prevent injury, the Intensifier must be shut off and depressurized to remove the male supply line connector from the outlet port. For quick disconnects with the system on, isolate the pressure with the isolation valve and open the vent valve to remove pressure on the connector.</b>
⑫	Intensifier Pressure Gauge (INTENSIFIER PRESSURE)	Visual Indication of the Intensifier pressure in psig.
⑬	Isolation Valve (ISOLATION)	Needle valve that shuts-off the pressure supply to the OUTLET Port. Pressure isolation is used for pressure accumulation troubleshooting procedures. It is also used to relieve pressure on the OUTLET port to disconnect the hose.

## Accessory Kit Items

The Calibrator includes the accessories listed Table 1-6, Table 1-7, and Table 1-8. Table 1-6 shows the accessories found in the Accessory Kit, Table 1-7 is a list of adapters in the Adaptors Kit, and Table 1-8 is a list of additional seals, filters, and fuses in the Spares Kit.

To order replacement parts or additional accessories, contact Fluke Calibration and reference the part numbers listed in the “List of Replacement Parts” section in the 4322 *Service Manual*.

Table 1-6. Accessories

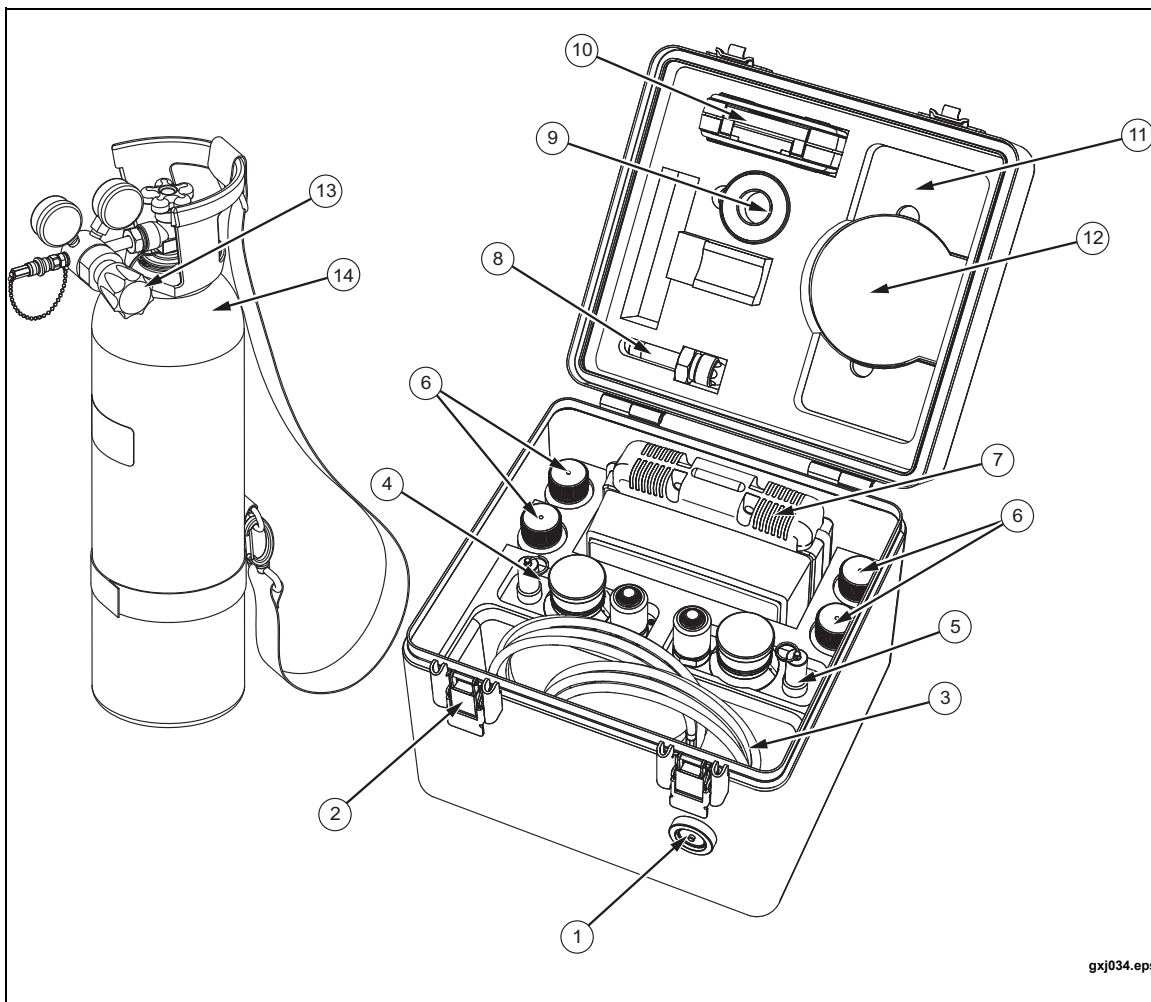

Item	Name	Function
①	Case Pressure Equalization Valve	Push to equalize the pressure inside the case to the pressure outside of the case. If the pressure is not equal, the case is difficult to open because it is sealed.

**Table 1-6. Accessories (cont.)**

Item	Description	Function
②	Spring-Loaded Case Latches	Spring-loaded latches that keeps the lid closed and sealed.
③	Hoses	System hoses. The Calibrator comes with: <ul style="list-style-type: none"> <li>• One Nitrogen Cylinder connection hose (6 ft)</li> <li>• One system interconnect hose (6 ft)</li> <li>• One blue UUT test hose (10 ft)</li> <li>• One orange UUT test hose (10 ft)</li> </ul>
④	CPS (orange)	Orange and blue Contamination Prevention System (CPS). See “UUT Cross-Contamination Prevention” in Chapter 2.
⑤	CPS (blue)	
⑥	CPS Waste Containers	Waste container (60 ml) with lid used with the CPS.
⑦	Adapters Kit	QC adapters for the UUT. See Table 1-7.
⑧	Nitrogen Cylinder Fill Adapter	Adapter used to connect a fill system to the Nitrogen Cylinder.
⑨	PTFE Tape	Tape to use on NPT fittings.
⑩	Spares Kit	Contains seals, fuses, and additional replacement parts. See Table 1-8.
⑪	DMM Holder	Foam cutout for a Fluke Digital Multimeter.
⑫	Manuals CD	CD that contains the <i>4322 Operators Manual</i> and <i>4322 Service Manual</i> .
⑬	Nitrogen Cylinder Regulator	Pressure regulator that lets you turn on and turn off pressure and also see the amount of pressure in the Nitrogen Cylinder.
⑭	Nitrogen Cylinder	<p>2,000 psig Nitrogen Cylinder. Maximum cylinder pressure is 2,000 psig.</p> <p style="text-align: center;"><b>⚠ Warning</b></p> <p><b>To prevent injury, do not over pressurize the Nitrogen Cylinder. Maximum pressure of the Cylinder is 2,000 psig.</b></p>

Table 1-7. Accessories - Adaptor Kit

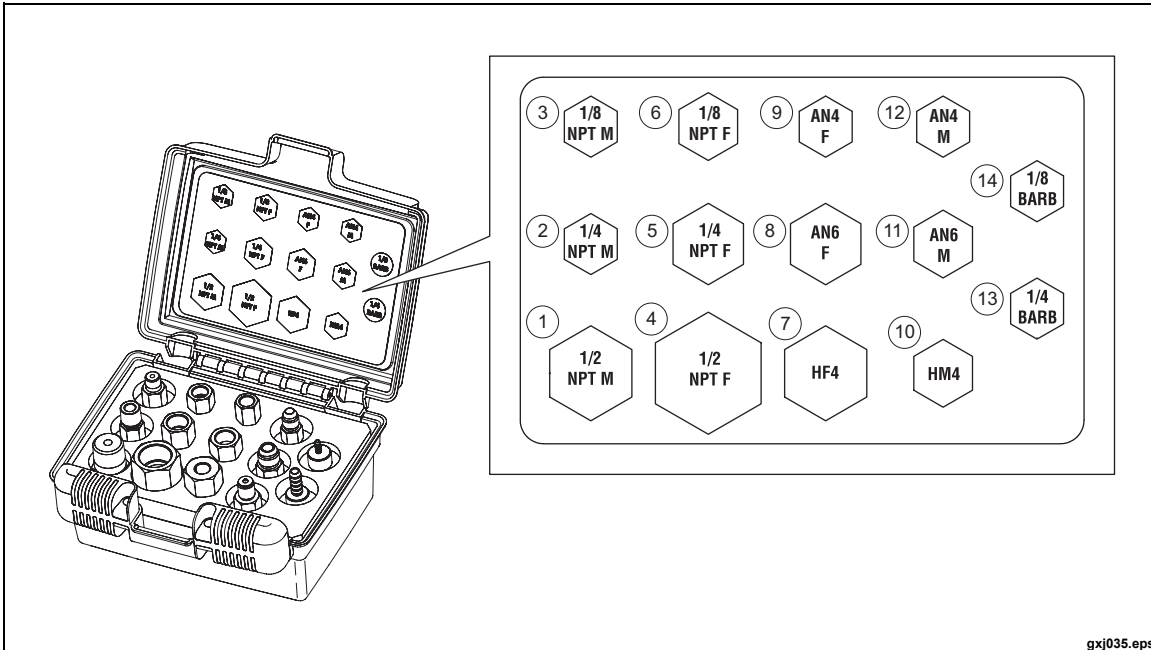

qxj035.eps

Item	Name	Function
①	FITTING, 1/2 MALE PIPE THREAD (NPT)	Quick-connect adapter. Each adaptor is marked with its maximum working pressure. See the Specifications section in this chapter for maximum working pressures.
②	FITTING, 1/4 MALE PIPE THREAD (NPT)	
③	FITTING, 1/8 MALE PIPE THREAD (NPT)	
④	FITTING, 1/2 FEMALE PIPE THREAD(NPT)	
⑤	FITTING, 1/4 FEMALE PIPE THREAD (NPT)	
⑥	FITTING, 1/8 FEMALE PIPE THREAD (NPT)	
⑦	FITTING, HF4 EQUIVALENT	
⑧	FITTING, AN6 FEMALE	
⑨	FITTING, AN4 FEMALE	
⑩	FITTING, HM4 EQUIVALENT	
⑪	FITTING, AN6 MALE	
⑫	FITTING, AN4 MALE	
⑬	FITTING, 1/4 ID HOSE BARB	
⑭	FITTING, 1/8 ID HOSE BARB	



**Table 1-8. Accessories - Spares Kit (Not Shown)**

Description
O-RING,0.05 IN. W X 0.042 IN. ID,VITON,75 DUROMETER,BROWN
O-RING,VITON,1MM W X 14MM ID,90 DURO,BLACK
O-RING,VITON,1MM W X 12MM ID,90 DURO,BLACK
O-RING,VITON,1MM W X 8MM ID,90 DURO,BLACK
O-RING,FLUOROCARBON,SHORE A 75,BLK,AS 568A-014,.489 ID,.070 W,ROHS COMPL.
48547,BUSHING NON-RIBBED
O-RING,CAST URETHANE,90 DURO,003 (0.060 W X 0.056 ID)
O-RING,VITON,2-002,3/64 ID,9/64 OD,3/64 W,DURO 90,BLACK
SEAL ASSEMBLY, HIGH PRESSURE,T61 SEAL /P02 BACKUP RING /FKM O-RING
O-RING,VITON,1MM W X 3.5MM ID,90 DURO,BLACK
4322-5772,DECAL, SPARE PARTS CASE
CASE,ABS,3.875INX2.375INX1.375IN,WITH HANDLE,BLACK
FUSE,5A,250VAC,TIME LAG,5X20MM,CERAMIC
4322-5933,CUT DETAIL, COALESCING FILTERS
FUSE,FUSE,5X20MM,1A,250V,SLOW
4322-5828,WRENCH,INTENSIFIER PISTON
4322-5860,TOOL, PISTON INSERTION, 4322
O-RING,0.05 IN. W X 0.042 IN. ID,VITON,75 DUROMETER,BROWN

## General Specifications

<b>Power Requirements</b> .....	100 V ac to 240 V ac (-15 %, +10 %), 50 Hz to 60 Hz
<b>Maximum Power Consumption</b>	
Controller .....	110 VA
Intensifier .....	250 VA
<b>Operating Temperature Range</b> .....	0 °C to 50 °C
<b>Storage Temperature Range</b> .....	-30 °C to 71 °C
<b>Humidity</b> .....	5 % to 95 %
<b>Vibration</b> .....	Meets MIL-T-28800D
<b>Altitude (operation)</b> .....	2,000 m
<b>Weight</b>	
Controller .....	~12 kg (27 lb)
Intensifier .....	~14 kg (31 lb)
Accessory Kit with Handheld Control.....	~12 kg (27 lb)
Nitrogen Cylinder .....	~12 kg (26 lb)
<b>Dimensions</b>	
Controller, Intensifier, and Accessory Kit.....	33 cm Height x 31 cm Width x 31 cm Depth (13 in Height x 12 in Width x 12 in Depth)
Nitrogen Cylinder.....	69 cm Height x 18 cm Diameter (27 in Height x 7 in Diameter)
<b>Remote Communication Interfaces</b> .....	RS-232, USB type B, IEEE-488.2, USB type A (PRINTER port only)
<b>Pressure Range</b> .....	3.5 kPa (0.5 psi) absolute to 70 MPa (10,000 psi)
<b>Operating Medium</b> .....	Dry nitrogen supply, or ambient air compressed by on-board pump.
<b>Warm-up Time</b> .....	15 minutes from power on, after at least 60 minutes ambient temperature acclimation time within the working temperature range.
<b>Safety</b> .....	IEC 61010-1: Overvoltage Category II, Pollution Degree2
<b>Electromagnetic Compatibility (EMC)</b>	
International .....	IEC 61326-1: Controlled Electromagnetic Environment CISPR 11: Group 1, Class A <i>Group 1: Equipment has intentionally generated and/or uses conductively-coupled radio frequency energy that is necessary for the internal function of the equipment itself.</i> <i>Class A: Equipment is suitable for use in all establishments other than domestic and those directly connected to a low-voltage power supply network that supplies buildings used for domestic purposes. There may be potential difficulties in ensuring electromagnetic compatibility in other environments due to conducted and radiated disturbances.</i> <i>Emissions that exceed the levels required by CISPR 11 can occur when the equipment is connected to a test object.</i>
Korea (KCC) .....	Class A Equipment (Industrial Broadcasting & Communication Equipment) <i>Class A: Equipment meets requirements for industrial electromagnetic wave equipment and the seller or user should take notice of it. This equipment is intended for use in business environments and not to be used in homes.</i>
USA (FCC).....	47 CFR 15 subpart B. This product is considered an exempt device per clause 15.103.

## Pressure Limits

### Recommended Supply Pressure

Controller .....	Greater of 700 kPa (100 psi) or 10 % above max target pressure, not to exceed 73 MPa (10,500 psi).
Intensifier .....	3.5 MPa to 14 MPa (500 psi to 2,000 psi)

**Max System Working Pressure** ..... 70 MPa (10,000 psi)

### Max Supply Pressure

Controller .....	73 MPa (10,500 psi)
Intensifier .....	20 MPa (3,000 psi)

**Max Nitrogen Cylinder Pressure** ..... 14 MPa (2,000 psi)

### Max Regulator Pressure

Inlet .....	28 MPa (4,000 psi)
Outlet .....	17 MPa (2,500 psi)

**Connections, Accessories, and Adapters** ..... Refer to the subsequent tables.

### Controller, Intensifier, and Nitrogen Cylinder Connections

Unit	Name	Type of Fittings <sup>[1]</sup>	Maximum Working Pressure Limit
Controller	TEST Port	IQC70 female, coupler located on CPS	70 MPa (10,000 psi)
	SUPPLY Port	IQC70 female coupler	
	Hose Purge	IQC70 male stem, located on CPS	
Intensifier	SUPPLY Port	IQC70 female coupler	70 MPa (10,000 psi)
	OUTLET Port	IQC70 female coupler	
N2 Cylinder Assembly	Cylinder Valve	CGA580 female coupler	20 MPa (3,000 psi)
	Regulator Inlet	CGA580 nipple	20 MPa (3,000 psi)
	Regulator Outlet	Miniature QC female coupler	20 MPa (3,000 psi)
Note:			
1. IQC70 is a Fluke Calibration interlocking quick connection nominally rated to 70 MPa (10,000 psi).			

### Adaptor Kit Fittings

Name	Type of Fittings <sup>[1]</sup>	Maximum Working Pressure Limit <sup>[2]</sup>
Fitting, 1/2 Male Pipe Thread (NPT)	IQC70 male stem	70 MPa (10,000 psi)
Fitting, 1/4 Male Pipe Thread (NPT)		
Fitting, 1/8 Male Pipe Thread (NPT)		
Fitting, 1/2 Female Pipe Thread (NPT)		
Fitting, 1/4 Female Pipe Thread (NPT)		
Fitting, 1/8 Female Pipe Thread (NPT)		
Fitting, DH200 female (HF4 Equivalent)		
Fitting, AN6 Female		
Fitting, AN4 Female		
Fitting, HM4 Equivalent		
Fitting, AN6 Male		
Fitting, AN4 Male		
Fitting, 1/4 ID Hose Barb		
Fitting, 1/8 ID Hose Barb	IQC70 male stem	700 kPa (100 psi)
Notes:		
1. IQC70 is a Fluke Calibration interlocking quick connection nominally rated to 70 MPa (10,000 psi).		
2. Working pressures indicated are for adaptors only. Actual pressure capability may be limited by the integrity or maximum working pressure of the fitting to which the adaptor is connected.		

### High-Pressure Hoses

Name	Type of Fittings <sup>[1]</sup>	Maximum Working Pressure Limit
Test hoses, 3 m (10 ft)	IQC70 male stem at one end, and IQC070 female coupling at the other.	70 MPa (10,000 psi)
Interconnect hose, 1.8 m (6 ft)	IQC70 male stem at both ends.	70 MPa (10,000 psi)
Supply hose, 1.8 m (6 ft)	IQC70 male stem at one end, and miniature QC male stem at the other.	20 MPa (3,000 psi) <sup>[2]</sup>
Notes:		
1. IQC70 is a Fluke Calibration interlocking quick connection nominally rated to 70 MPa (10,000 psi).		
2. Hose limited to 3,000 psi due to miniature QC used to connect to the fitting on the regulator.		

## Measurement Specifications

**Barometer Module Range** ..... 70 kPa to 110 kPa absolute (10 psi to 16 psi) absolute

### Pressure Transducer Module Ranges

Note: Pressure modules are switched automatically and transparently to the operator.

A150k.....	3.5 kPa to 150 kPa absolute (0.5 psi to 22 psi)
G700k .....	50 kPa to 700 kPa gauge (7 psi to 100 psi)
G10M .....	700 kPa to 10 MPa gauge (100 psi to 1,500 psi)
G70M .....	10 MPa to 70 MPa gauge (1,500 psi to 10,000 psi)

**Resolution** ..... Greater of 0.001% of reading or 0.00004 psi (0.28 Pa)

### Measurement Uncertainty

Measurement Mode	Range	Uncertainty <sup>[1]</sup>
Gauge <sup>[2]</sup>	-98 kPa to +28 kPa (-14.2 psi to +4 psi) gauge	±25 Pa (0.0036 psi, 0.1 in H <sub>2</sub> O at 20 °C)
	28 kPa to 70 MPa (4 psi to 10,000 psi) gauge	±0.1 % of reading
Absolute	3.5 kPa to 130 kPa (0.5 psi to 19 psi) absolute	±25 Pa (0.0036 psi, 0.1 in H <sub>2</sub> O at 20 °C)
	130 kPa to 70 MPa (19 to 10,000 psi) absolute	±0.1 % of reading
Vacuum <sup>[2]</sup>	0 kPa to 98 kPa (0 to 14.2 psi, 0 to 29 inHg)	±25 Pa (0.0074 inHg)
Notes:		
1. Measurement uncertainty is defined as the maximum deviation from the indicated value of measured pressure for 1 year after alignment including hysteresis, linearity, repeatability, stability, temperature, humidity effects, and calibration reference standard measurement uncertainty. Expression of uncertainty uses a coverage factor of 2 and conforms with the recommendations of the ISO Guide to the Expression of Uncertainty in Measurement.		
2. Negative gauge and vacuum pressure values assume the ambient atmospheric pressure is approximately 101 kPa (14.7 psi) absolute.		

## Pressure Control Specifications

**Control Precision** ..... Greater of ± 0.025 % of reading or ± 25 Pa (0.0036 psi).

### Control Ranges

Pressure Source	Measure Mode	Range
On-board Pump	Gauge <sup>[1]</sup>	-98 kPa to 2 MPa (-14.2 to 300 psi)
	Absolute	3.5 kPa to 2 MPa (0.5 to 300 psi)
	Vacuum (negative gauge) <sup>[1]</sup>	0 to 98 kPa (0 to 14.2 psi, 0 to 29 inHg)
External Gas Supply	Gauge	28 kPa to 70 MPa (4 to 10,000 psi)
	Absolute	130 kPa to 70 MPa (19 to 10,000 psi)
Note:		
1. Negative gauge and vacuum pressure values assume the ambient atmospheric pressure is approximately 101 kPa (14.7 psi) absolute.		

**Typical Control Set Times**

Measure Mode	Range	Time (seconds) <sup>[5]</sup>
Gauge <sup>[7]</sup>	<28 kPa (4 psi)	90 <sup>[1] [6]</sup>
	28 kPa to 700 kPa (4 to 100 psi)	30 <sup>[2]</sup>
	700 kPa to 7 MPa (100 to 1,000 psi)	30 <sup>[3]</sup>
	7 to 70 MPa (1,000 to 10,000 psi)	60 <sup>[4]</sup>
Absolute	<14 kPa (2 psi)	180 <sup>[1] [6]</sup>
	14 to 130 kPa (2 to 19 psi)	90 <sup>[1] [6]</sup>
	130 to 700 kPa (19 to 100 psi)	30 <sup>[2]</sup>
	700 kPa to 7 MPa (100 to 1,000 psi)	30 <sup>[3]</sup>
	7 to 70 MPa (1,000 to 10,000 psi)	60 <sup>[4]</sup>
Vacuum <sup>[7]</sup>	>88 kPa (12.7 psi, 26 inHg)	180 <sup>[1] [6]</sup>
	0 to 88 kPa (12.7 psi, 26 inHg)	90 <sup>[1] [6]</sup>
Notes: 1. Assumes 100 cc test volume and pressure steps no greater than 17 kPa (2.5 psi), uses on-board pump control. 2. Assumes 100 cc test volume and pressure steps no greater than 70 kPa (10 psi), using with external gas supply. 3. Assumes 50 cc test volume and pressure steps no greater than 700 kPa (100 psi), using with external gas supply. 4. Assumes 25 cc test volume and pressure steps no greater than 7 MPa (1,000 psi), uses with external gas supply. 5. Set times are typical and reflect time to ready indication using default control limits in dynamic control mode. 6. Times for sub-atmospheric set points assume that the temperature is below the boiling point for the target pressure of any liquid in the UUT and CPS. 7. Negative gauge and vacuum pressure values assume the ambient atmospheric pressure is approximately 101 kPa (14.7 psi) absolute.		

**Pressure Switch Testing Specifications (Handheld)**

- Maximum Input Voltage**..... 10 V (protected up to 1,000 V dc)  
**Resistance Thresholds** ..... Set to 1 KΩ opened / 90 Ω closed (±5 %)  
**Dead-band Limits**..... -98 kPa (-14.2 psi) gauge to 70 MPa (10,000 psi) gauge



# Chapter 2 Setup

Title	Page
Introduction.....	2-3
Quick-Connector Fittings .....	2-3
Configure the Pressure Supply.....	2-4
Controller Only.....	2-4
Controller and Nitrogen Cylinder.....	2-5
Controller and Intensifier .....	2-5
Internal and External Supply Setting.....	2-6
Contamination Prevention .....	2-8
Install the CPS .....	2-9
Remove the CPS.....	2-10
Connect the Handheld Control Accessory .....	2-10
Connect to a Unit Under Test (UUT) .....	2-11
Make a Head-Height Correction.....	2-14
Controller Settings .....	2-15
The Settings Menu.....	2-15
Security Levels .....	2-20
Sounds and Alarm Volume.....	2-21





## Introduction

This chapter supplies information and instructions on how to configure the Calibrator for operation.

## Quick-Connector Fittings

To quickly connect and disconnect hoses, both the Controller and the Intensifier are equipped with Fluke IQC070 interlocking quick-connects (QC) with nominal maximum working pressure (MWP) of 70 MPa (10,000 psi). Maximum working pressures of the adapter fittings supplied in the Adapters Kit are listed in the Specifications section in Chapter 1.

To connect a hose to a QC, push the male connector on the hose into the female connector on the unit. To release the connector, remove pressure from the connector and push down on the collar (see Figure 2-1). The Accessory Kit includes a variety of QC adapters and fittings to attach to a UUT.

### **⚠ Warning**

**To prevent injury and damage to the system, do not try to disconnect or connect a hose when pressure is on the QC connectors. The QC is locked when pressure is applied.**

Each QC fitting contains a small, in-line filter to prevent system contamination. The filters are replaceable and can be replaced by qualified service personnel, see the *4322 Service Manual* for instructions on how to replace the filters.

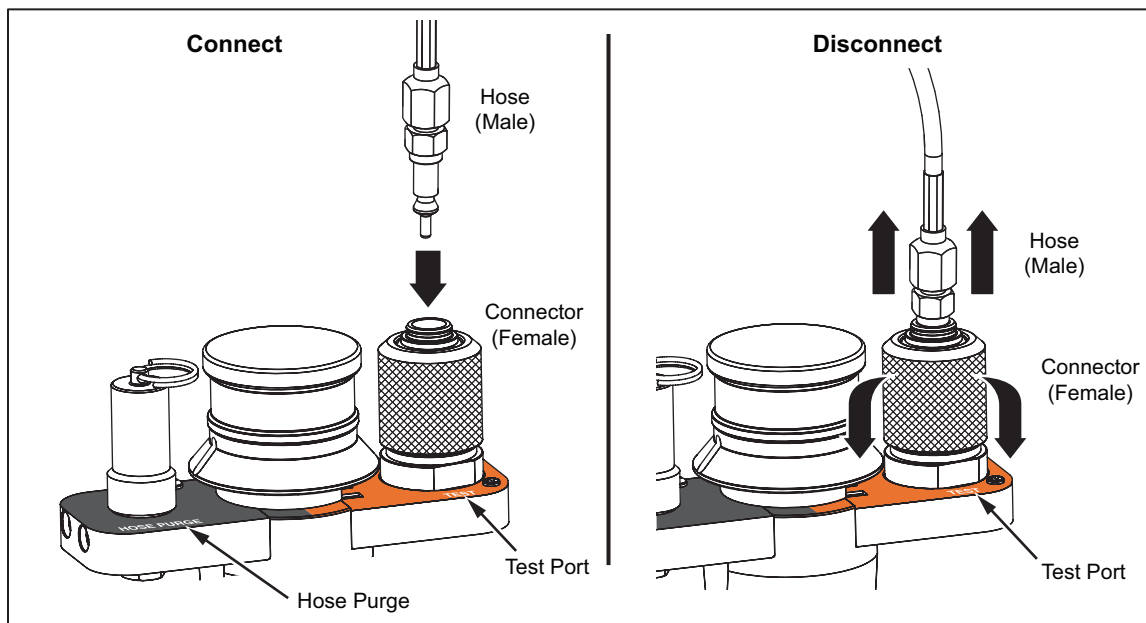

Figure 2-1. Quick-Connector Operation Example

gxj003.eps

## Configure the Pressure Supply

The Calibrator has three configurations to maximize portability as shown in Figure 2-2. Read the subsequent sections from more information on each configuration along with instructions on how to set up the Calibrator for the configuration.

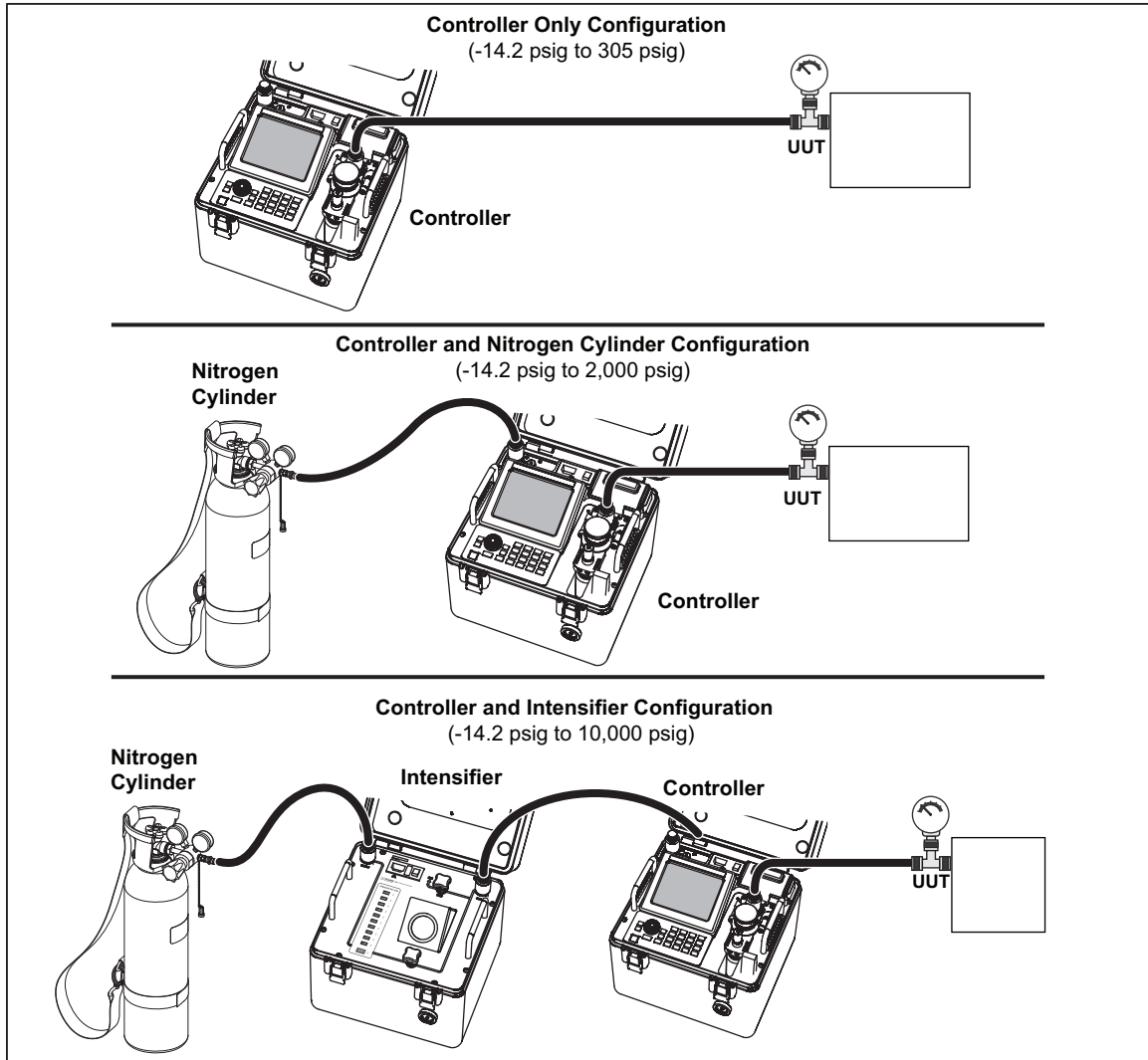

Figure 2-2. Pressure Supply Configurations

gww003.eps

### Controller Only

The Controller only configuration provides maximum portability when the pressure necessary to calibrate the UUT is between -14.2 psig and 305 psig. In this configuration, the Controller is directly connected to the UUT without an external supply. The Controller has an internal electric pump that can generate and supply up to 305 psig of compressed air without an external source of pressure. If more than 305 psig is necessary for the calibration, connect the Controller to an external supply such as the Nitrogen Cylinder or Intensifier.

### Controller and Nitrogen Cylinder

The Controller and Nitrogen Cylinder configuration provides maximum portability when the pressure necessary to calibrate the UUT is between 306 psig and 2,000 psig.

#### Note

*The Controller cannot boost supply pressure from the Nitrogen Cylinder. The pressure available to the UUT is equal to the supply pressure in the Nitrogen Cylinder.*

To connect the Nitrogen Cylinder supply to the Controller (see Figure 2-2):

1. Make sure the Nitrogen Cylinder pressure is more than 500 psig and no more than 2,000 psig. To service and fill the Nitrogen Cylinder, see Chapter 6.

#### **⚠ Warning**

**To prevent injury, do not over pressurize the Nitrogen Cylinder. Maximum pressure of the cylinder is 2,000 psig.**

2. Connect the male end of the regulator hose to the female connector on the nitrogen cylinder regulator.

#### Note

*The regulator hose has a unique regulator QC fitting that only connects to the regulator on the Nitrogen Cylinder.*

3. Connect the male end of the regulator hose with the IQC070 male fitting to the female IQC070 fitting at the SUPPLY port on the Controller. See “Quick-Connector Fittings” on page 2-3.
4. Fully open the Nitrogen Cylinder regulator to supply pressure. Close the Nitrogen Cylinder regulator when the Controller is not in use.

### Controller and Intensifier

The Controller and Intensifier configuration is used when the pressure necessary to calibrate the UUT is between 2,000 psig (or available bottle pressure) and 10,000 psig. The Intensifier supplies pressure on demand as long as sufficient supply pressure (500 psig) to the Intensifier is available.

#### **⚠ Warning**

**To prevent injury, do not over pressurize the Nitrogen Cylinder. Maximum pressure of the cylinder is 2,000 psig.**

#### **⚠ Caution**

**To prevent damage to the Intensifier, only use dry nitrogen to supply the Intensifier.**

#### Notes

- *The regulator hose has a special regulator QC fitting that only connects to the regulator on the Nitrogen Cylinder.*
- *The Intensifier is not a completely sealed system and will deplete the gas supply if left on while not in use. To preserve gas, close the regulator and turn off the Intensifier when not in use.*
- *The Nitrogen Cylinder must have at least 500 psig to supply the Intensifier.*

To connect the Intensifier to the Controller (see Figure 2-2):

1. Connect the Nitrogen Cylinder to the Intensifier as follows:
  - a. Make sure the Nitrogen Cylinder pressure is more than 500 psig and no more than 2,000 psig. To service the Nitrogen Cylinder, see Chapter 6.
  - b. Connect the male end of the regulator hose to the Nitrogen Cylinder regulator port.
  - c. Connect the male end of the regulator hose with the IQC070 male fitting to the female IQC070 fitting at the SUPPLY port on the Controller. See “Quick-Connector Fittings” on page 2-3.
2. Connect the Intensifier to the Controller as follows:
  - a. Connect the two male ends of the system interconnect hose to the OUTPUT port on the Intensifier and the SUPPLY port on the Controller.
  - b. On the Intensifier, make sure the Vent Valve is closed and the Isolation Valve is full open.
  - c. Fully open the Nitrogen Cylinder regulator to supply pressure to the Intensifier.

### **Internal and External Supply Setting**

Regardless of the Calibrator configuration used, the Controller gives the user the ability to select which type of pressure source to use when the target pressure is in the 4 psig to 305 psig range. The two selections are: External (Intensifier or Nitrogen Cylinder) and Internal supply (electric motor driven pump). The supply can be set from the Main menu or in the Settings menu.

If External is selected, the Controller uses the connected external source for pressures greater than 4 psig. If Internal is selected, the Controller uses the internal electric motor driven pump to generate the pressure between the pressure of 4 psig to 305 psig. The controller internal supply is always used to generate and control pressure less than 4 psig and absolute pressure equivalent (approximately 19 psi absolute), including all subatmospheric (vacuum points).

If Internal is set and a test is run, the Controller automatically switches between the supply selections to complete the test. For example, a test has seven test points (refer to Figure 2-3). The Controller uses the internal electric motor driven pump to complete test point one (240 psig). The next test point pressure requires 480 psig. The Controller automatically changes the supply source to External because the test point is above 305 psig. The Controller remains in External to complete test points four and five. At test point six, the Controller automatically changes back to Internal to complete test point six (240 psig).

#### *Note*

*If an external source such as the Intensifier or the Nitrogen Cylinder is not connected and the Controller changes the supply to External, the Controller will not reach the next target pressure. In this case, abort the test and check the supply pressure and connections.*

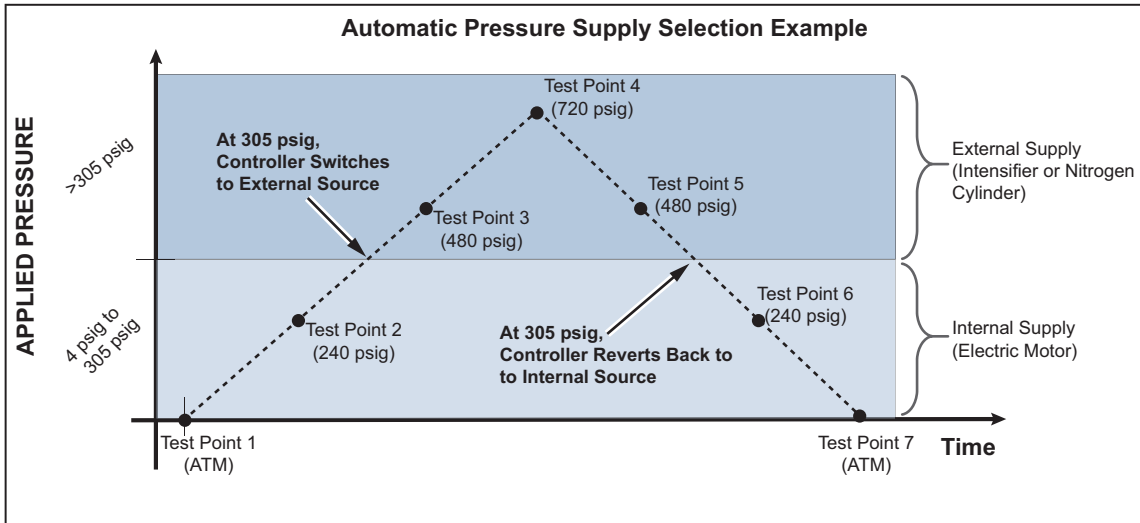

Figure 2-3. Automatic Supply Switch Example

gxj064.eps

Change the Supply setting as follows (see Figure 2-4).

From the Main menu:

1. Select **Supply:** in the Main menu to open the supply selection menu.
2. Select **External** or **Internal**.

Through the Settings menu:

1. From the Main menu, select **Settings** to open the settings menu.
2. Select the **Control** tab.
3. Select **4.0-305psi Supply**.
4. Select **External** or **Internal**.

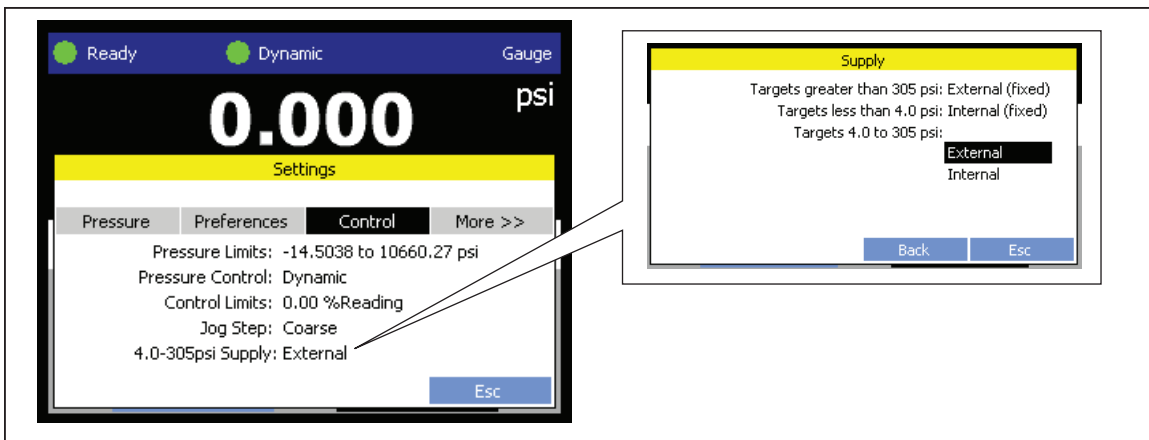

Figure 2-4. Supply Selection

gxj053.eps

## Contamination Prevention

To prevent damage to the Controller from contaminants that can be in the UUT and hoses such as water, dirt, oil and grease, the Controller is equipped with a Contamination Prevention System (CPS). The CPS consists of an electronically controlled vent, a male and female QC fitting, a filter, and a purge port with a 60 ml plastic waste container (see Figure 2-5). The UUT connects directly to the CPS and does not require a separate inline connection.

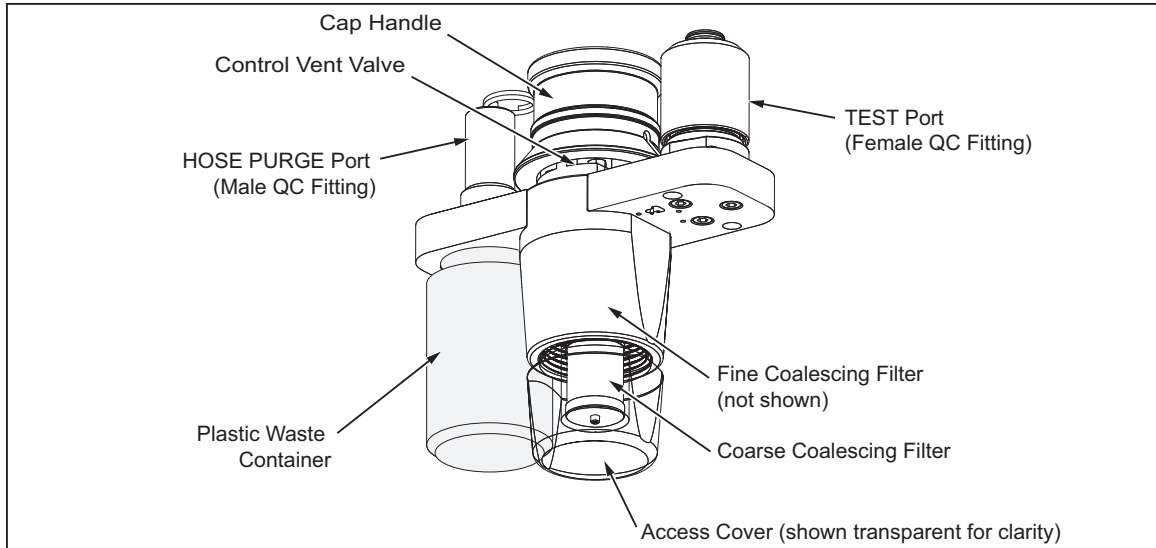

Figure 2-5. The CPS

gxj023.eps

The Accessory Kit includes two separate sets of test hoses and two CPS accessories. These two components are each identified by either a blue or orange mark as shown in Figure 2-6. The materials and construction of each set is identical, but the suggested use is for the blue set to be the "clean" configuration (used for UUTs that operate in gas, fresh water, freons, etc.) and the orange set to be the "dirty" configuration (used for UUTs that operate in salt water, oils, hydraulic fluids, and fuels).

The division of fluid service for these configurations is the decision of the user. Before a calibration is started, select a configuration and only use that configuration to calibrate UUTs that contain similar fluids or gasses.

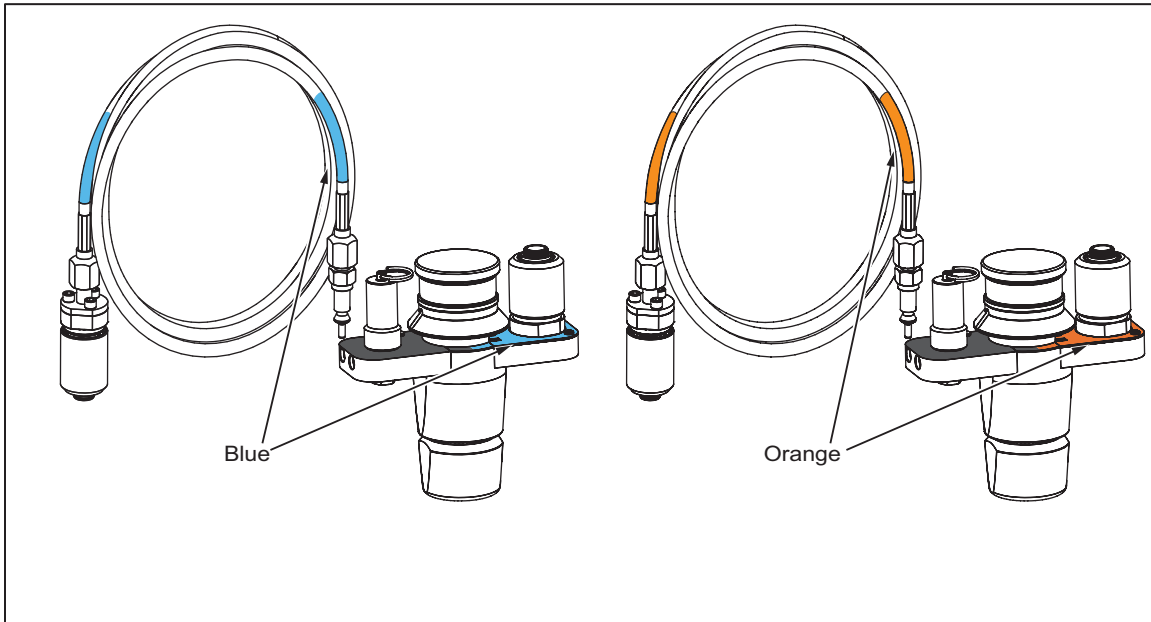

Figure 2-6. CPS Configurations

gxj007.eps

### Install the CPS

1. Choose a blue or orange marked CPS to use.
2. Unscrew the bottom CPS access cover and check to make sure the coalescing filters are installed and tight. Reinstall the CPS access cover when finished.
3. Carefully put the CPS into the Controller. Make sure the pressure-lock fittings lock and the CPS is fully seated (see Figure 2-7).

#### **⚠ Caution**

**To prevent damage to the Controller, drain as much fluid as possible out of the UUT before it is connected to the Controller. Empty the waste container after each test.**

#### *Note*

*The CPS is held in place by a pair of pressure lock fittings that are locked when pressure is applied to prevent CPS removal. When pressure is not applied, the CPS can be easily lifted from the Controller (see Figure 2-7).*

4. Connect the male end of the hose or UUT QC adaptor to the TEST port on the CPS.

#### **⚠ Caution**

**To prevent damage to the UUT, always use the test hose with the same color marking as the CPS. See “UUT Cross-Contamination Prevention” on page 2-8.**

### Remove the CPS

1. Push **VENT** on the Controller to relieve pressure on the CPS and QC fittings.
2. Purge the test hose (see “Hose Purge” in Chapter 3).
3. Disconnect the test hose from the TEST port.
4. Hold the top of the CPS and pull upwards to remove.
5. Clean the CPS and test hose and put them in the Accessory Kit.

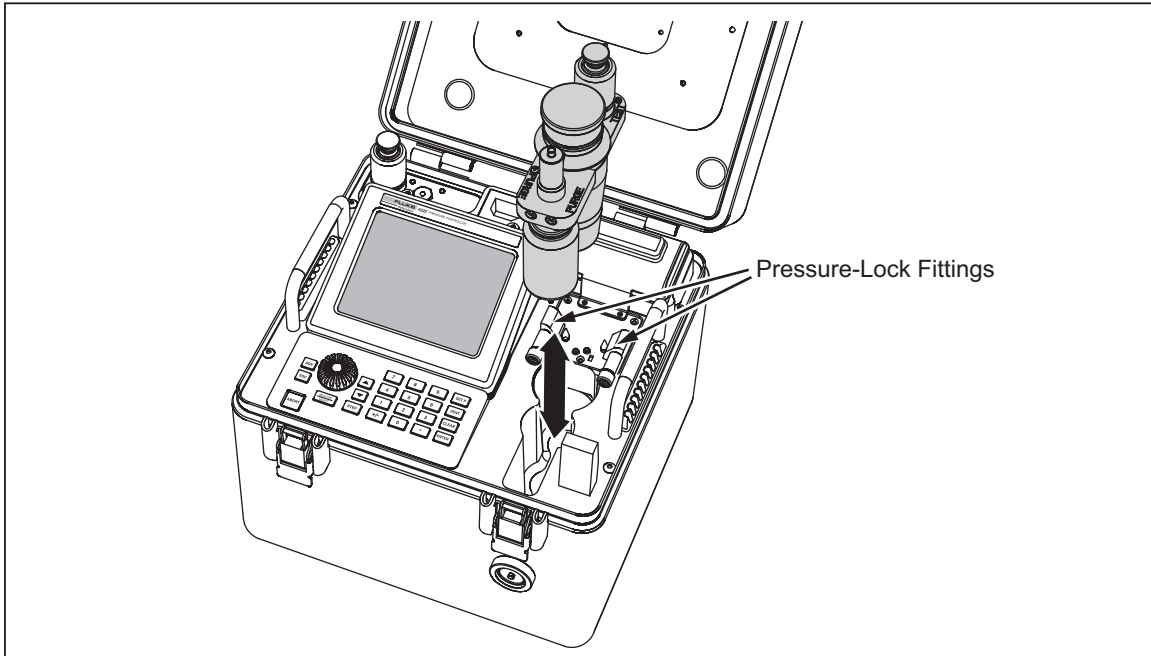

Figure 2-7. CPS Installation and Removal

gxj022.eps

### Connect the Handheld Control Accessory

Connect the Handheld as follows:

1. Open the rubber communication module protective cover on the Controller.
2. Connect one end of the cord to the “Handheld” port on the Controller.
3. Connect the other end of the cord to the Handheld (see Figure 2-8).



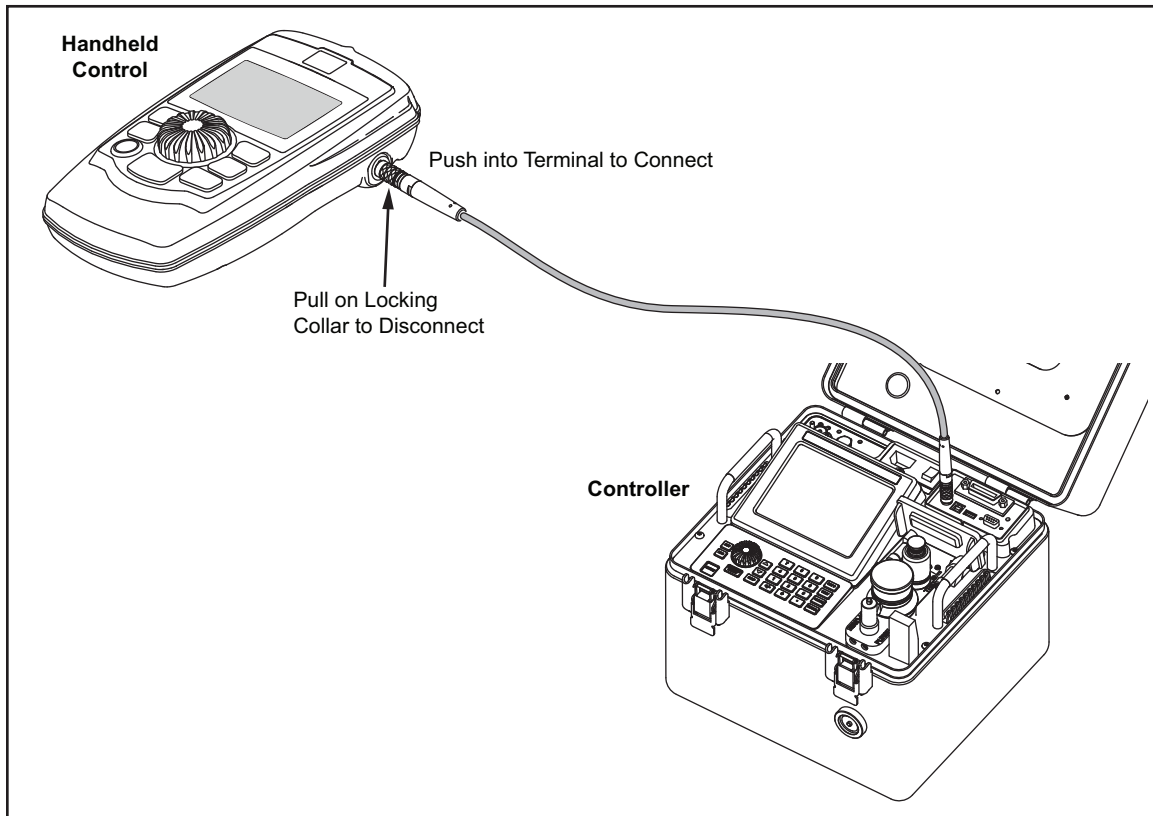

Figure 2-8. Handheld Control Connection

gxj057.eps

Disconnect the Handheld as follows:

1. Remove the cord from the Controller and the Handheld Control. Pull back the collar on the connector to disengage the collar lock.

**⚠ Caution**

**To prevent damage to the cord or the product, do not pull on the cord to disconnect it from the Controller or the Handheld. Pull back on the collar on the connector to properly disconnect the cord.**

2. Clean the Handheld Control and store in the Accessory Kit or the lid of the Controller.
3. Close the rubber communication module protective cover on the Controller.

## **Connect to a Unit Under Test (UUT)**

Use the procedure in this section to prepare a UUT for calibration.

1. Remove the pressure fitting on the UUT so that a QC fitting can be installed later in this procedure.
2. Drain the UUT of excessive fluids (if necessary).
3. Purge the hose to ensure cleanliness and to prevent contamination. Use the instructions in “Hose Purge” in Chapter 3.

*Note*

*Perform a hose purge anytime contamination is suspected.*

4. Find the correct size QC fitting inside the Adapter Kit (see “Accessory Kit Items” in Chapter 1).

**⚠ Caution**

To prevent damage to the UUT, make sure to select the correct size adapter fitting with the correct thread type. Ensure that all hardware used is rated to adequate working pressure, and that all equipment is in proper working order (for example, no cracks or stripped threads).

**⚠ Warning**

To prevent injury, only trained personnel should make connections. Always use standard and/or manufacturer recommended procedures to connect each device.

5. Wrap the threads of the QC fitting with Teflon tape (only if required for tapered pipe threads) then put the fitting on the UUT (see Figure 2-9).

*Note*

*Failure to properly tighten the adapter fitting can result in a leak.*

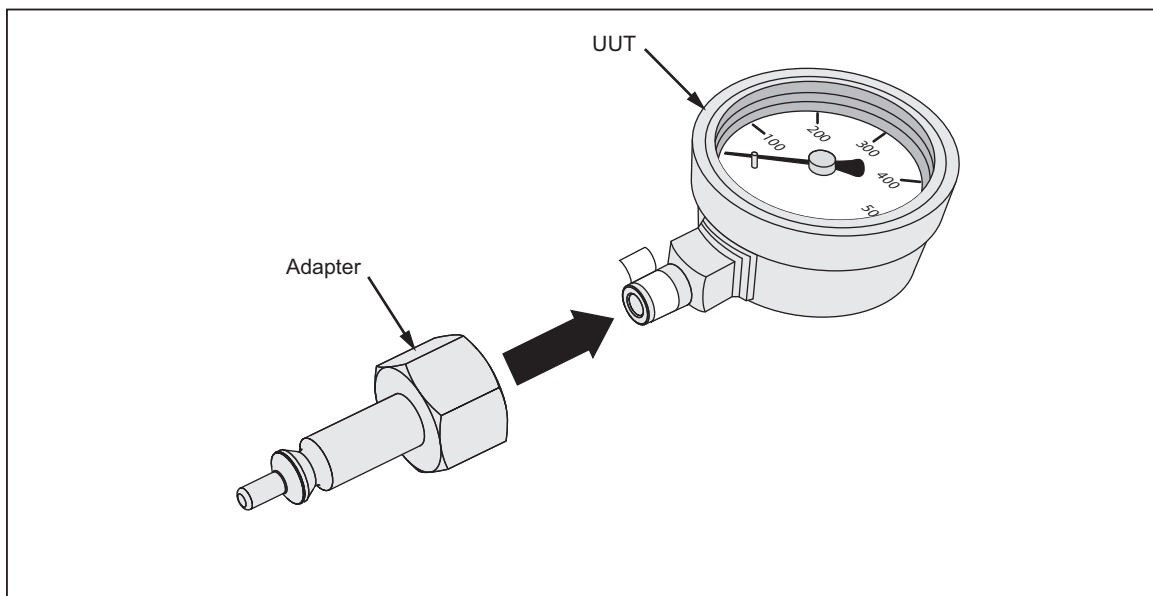

**Figure 2-9. UUT Connection Example**

gxi044.eps

6. Connect the female end of the test hose to the male QC fitting on the UUT.
7. Connect the male end of the test hose to the TEST port on the Controller.

*Note*

*The test hose is not required for every test. In some cases, the adaptor can be connected to the UUT can be mounted directly into the TEST port.*

8. Turn on the Controller.

9. Perform a leak test. Use the instructions in “Leak Test” in Chapter 3. If a leak is found, correct the leak and attempt the leak test again.

**⚠ Caution**

**To prevent damage to a UUT, do not over tighten the QC fitting. If a leak is located between the QC fitting and UUT, make sure the correct adapter is used.**

**Additional Steps For Pressure Switches Only:**

10. Connect the Handheld to the Controller.
11. Connect the black lead from the Handheld Control to the negative terminal (-) on the pressure switch. See Figure 2-10.
12. Connect the red lead from the Handheld Control to the positive terminal (+) on the pressure switch. See Figure 2-10.

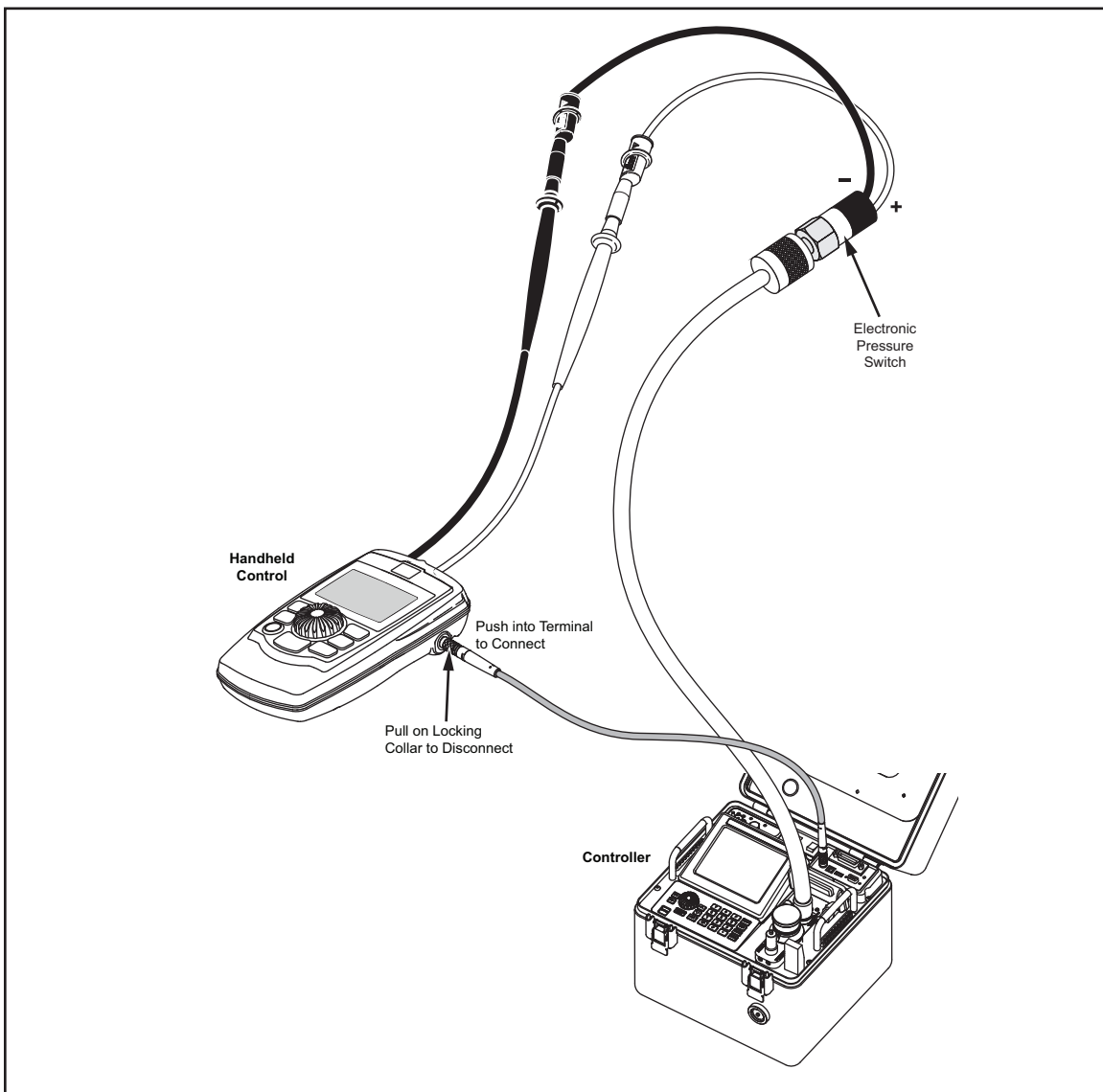

**Figure 2-10. Pressure Switch Lead Connections**

gxj080.eps

## Make a Head-Height Correction

For calibration of a UUT at a different height than the Controller, it is necessary to make a head-height correction. The head-height correction is the vertical difference between the reference plane of the UUT to the top of the Test port on the Controller in inches or centimeters.

### Note

*If the UUT does not have a reference plane marking, use the bottom of the UUT as the reference plane.*

After the measurement is made, the measurement value is entered into the Controller. Use a positive (+) value if the UUT is above the Controller and a negative (-) value if the UUT is below (see Figure 2-11).

### ⚠ Caution

**Failure to make a head-height correction can result in an inaccurate calibration.**

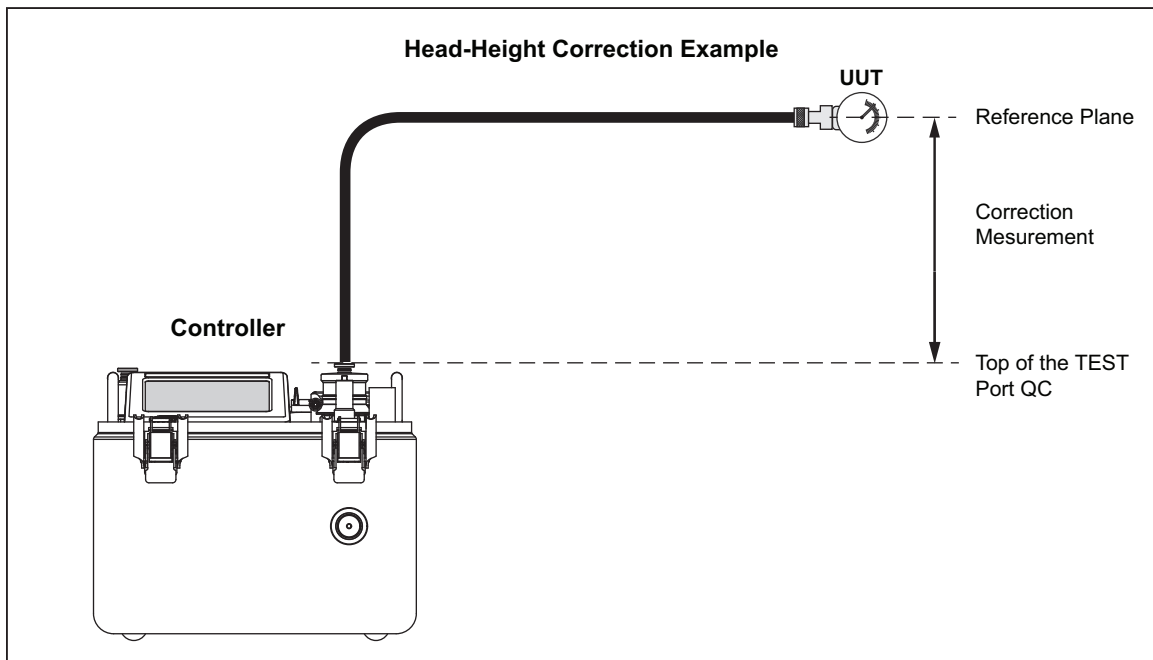

Figure 2-11. Head-Height Correction Example

gxj026.eps

Make a Head-Height Correction from the Main menu as follows:

1. Select **Head** on the Main menu to open the Head menu.
2. Key in **Height, Unit, and Medium**.
3. Select **OK** to save and close the menu.

Make a Head-Height Correction through the Settings menu as follows:

1. From the Main menu, select **Settings** to open the settings menu.
2. Select the **Pressure** tab.
3. Key in **Height, Unit, and Medium**.
4. Select **OK** to save and close the menu.

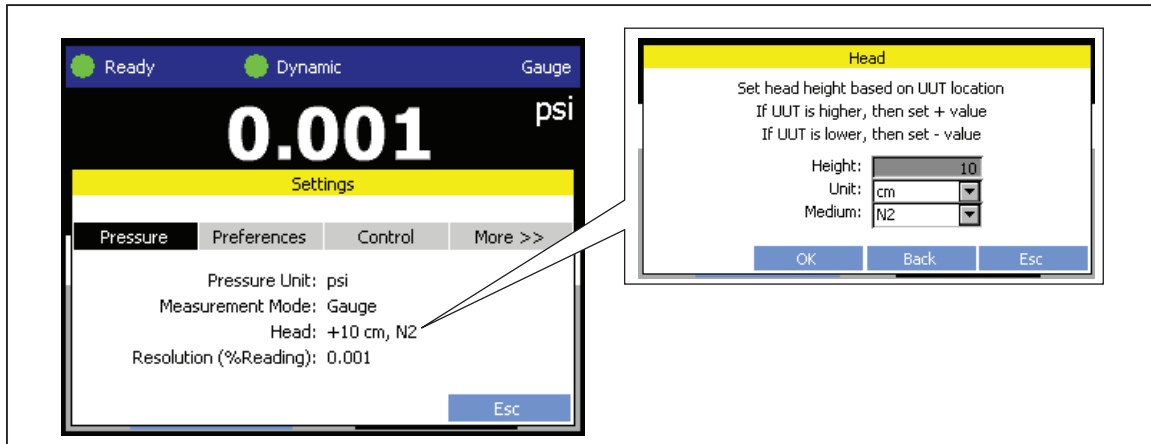

Figure 2-12. Head Menu

gxj067.eps

## Controller Settings

### The Settings Menu

The Settings menu screen supplies quick access to the six setting submenus (Table 2-1). The submenus are referred to as “tabs” such as “the Preferences tab” or “the Pressure tab”. The Settings menu can only show three tabs at a time. Use the “**More >>>**” tab to cycle through the tabs not shown.

#### Note

*Test Sequences contain settings such as Measurement Mode and Unit of Measure that are also defined in the Settings menu. During a Test Sequence, the Controller temporarily changes to the settings contained in the test file. After the test is complete, the Controller automatically reverts back to the settings set in the Settings menu.*

Table 2-1. Settings Menu

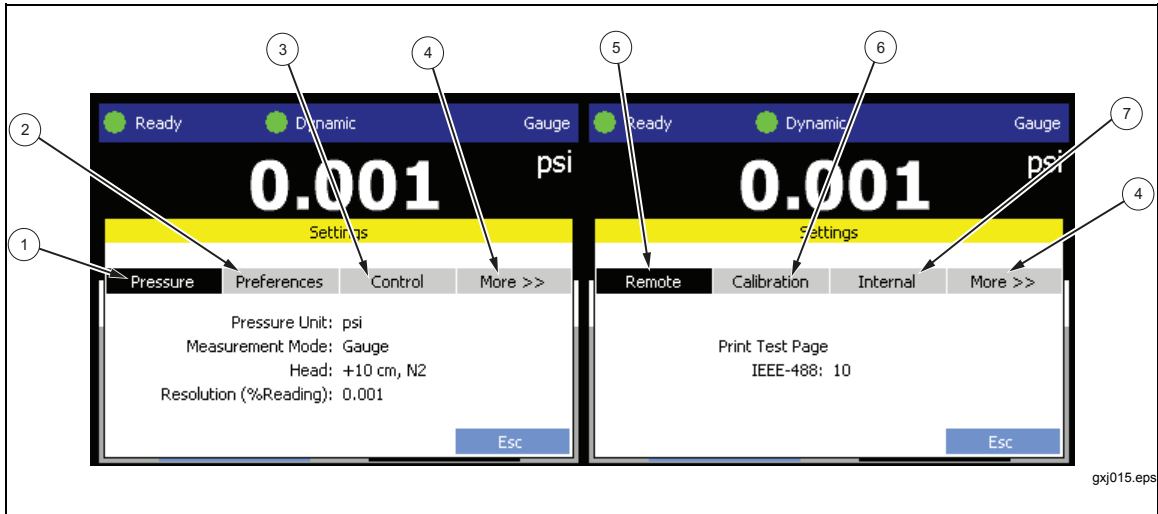

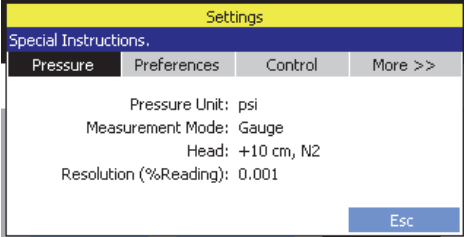
Item	Tab	Function
①	Pressure	<p>Contains basic pressure settings.</p>  <p><b>Pressure Unit</b> – Set the unit of measure. See “Unit of Measure” in Chapter 3 for a list of units available. Additional custom pressure units can be made.</p> <p><b>Measurement Mode</b> - Set the Measurement mode. See “Measurement Modes” in Chapter 3.</p> <p><b>Head</b> - Set the head-height correction. See “Make a Head-Height Correction” in Chapter 2.</p> <p><b>Resolution (% of Reading)</b> – Set the resolution of the measurement on the Main menu. See “Measurement Resolution” in Chapter 3.</p>

**Table 2-1. Settings Menu (cont.)**

Item	Tab	Function
②	Preferences	<p>Contains general system preferences.</p> <div style="text-align: center;">  </div> <p><b>Screen Saver</b> – Set when and what type of screen saver to display.</p> <p><b>Sound</b> – Set the system sound to Off, Low, Medium, or High. See “Sounds and Alarm Volume” on page 2-21.</p> <p><b>Time</b> – Set the date and time. The time format can be changed from this menu.</p> <p><b>On-Screen Instructions</b> – Changes the amount of helpful text shown in the message bar on the main menu. Standard shows all helpful text and Reduced shows a minimized amount of helpful text.</p> <p><b>Security</b> – Set the Controller security to On or Off. See “Security Levels” on page 2-20.</p>
③	Control	<p>Contains pressure control preferences.</p> <div style="text-align: center;">  </div> <p><b>Pressure Limits</b> – Set the upper and lower pressure limits. See “Set the Pressure Limits and Control Limits” in Chapter 3.</p> <p><b>Pressure Control</b> – Set the Pressure Control Mode. See “Change the Pressure Control Mode” in Chapter 3.</p> <p style="text-align: center;"><i>Note</i></p> <p><i>Dynamic Control with Jog Approach is only available as part of a Test Sequence.</i></p> <p><b>Control Limits</b> – Set the Control Limits. See “Pressure Limits and Control Limits” in Chapter 3.</p> <p><b>Jog Step</b> – Set the Jog Step percentage. See “Jog Step Pressure Up or Down” in Chapter 3.</p> <p><b>4.0-305 psi Supply</b> - Set the default supply to use in the 4 psig to 305 psig range. See “Internal and External Supply Setting” on page 2-6.</p>
④	More >>>	Cycle through the tabs not shown.

Table 2-1. Settings Menu (cont.)

Item	Tab	Function
⑤	Remote	<p>Contains remote operation configuration settings.</p>  <p><b>Print Test Page</b> – Send a test page to the connected printer to test the connectivity.</p> <p><b>IEEE-488</b> – Set the IEEE address.</p>
⑥	Calibration	<p>Contains Controller calibration settings and information.</p>  <p><b>View/Edit Calibration</b> – View or edit the calibration coefficients. See the 4322 <i>Service Manual</i> for calibration information and procedures.</p> <p><b>Run Calibration</b> – Opens a Calibration menu with tools to calibrate the Controller. See Chapter 7 or the 4322 <i>Service Manual</i> for calibration information and procedures.</p> <p><b>Past Results</b> – View past calibration results.</p> <p><b>Calibration Settings</b> – Set a custom calibration tolerance and apply it to a module. See Chapter 7.</p> <p><b>BaroCheck</b> – See “AutoZero and BaroCheck” in Chapter 3.</p>

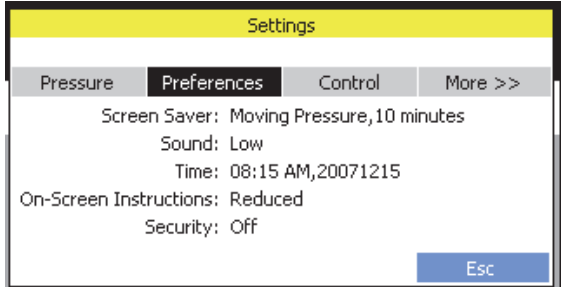
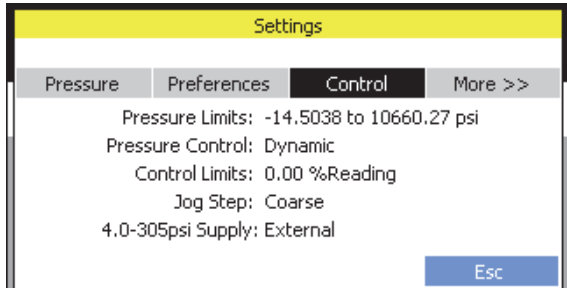
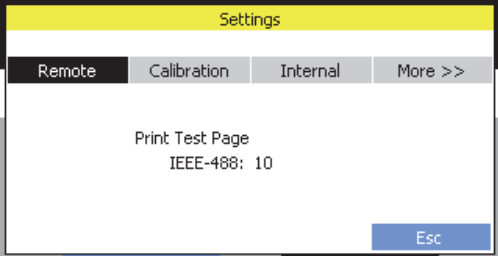
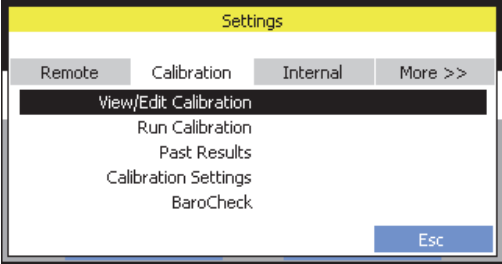
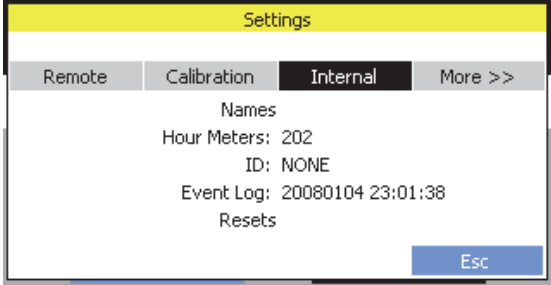

**Table 2-1. Settings Menu (cont.)**

Item	Tab	Function
⑦	Internal	<p>Contains maintenance settings.</p>  <p><b>Names</b> – The Controller has a UUT library that can store the names of commonly used UUT names and UUT manufacturers. This feature allows UUTs to be quickly loaded into tests when tests are configured.</p> <p><b>Hour Meters</b> – Opens a menu that shows the internal piston pump hours (resettable), how many hours that system has been pressurized(total and since last calibration), and total amount of hours that Controller has been turned on. See Chapter 6 for more information and reset instructions.</p> <p><b>ID</b> – Set an alpha-numerical identification to identify the Controller. See “Controller Identification” in Chapter 6.</p> <p><b>Event Log</b> – Event log that tracks and records errors and important system events such as calibrations and overpressures. See “Event Log” in Chapter 6.</p> <p><b>Resets</b> – A series of reset functions for maintenance personnel to reset the Controller settings. See “Reset Controller Settings” in Chapter 6.</p>

### Security Levels

The Controller is equipped with three user-level access security levels (Off, Low, and High) to protect from undesired changes to the settings (see Table 2-2). The Controller comes from the factory with the security level set at Low. A Low level restriction is recommended for normal day-to-day operations.

#### **⚠ Caution**

**To prevent configuration changes to the metrological information and calibration information, it is recommended that the low security level be set at a minimum.**

Table 2-2. Security Levels

Security Level	Definition
Off	No security applied.
Low	Protects the specific metrological information and calibration information settings. Low security is the default setting.
High	Protects all operating parameters. It is intended to minimize user choices, for example to perform repeated identical calibrations under consistent conditions.

Table 2-3. Security Level Diagram

Function or Area	Changes Allowed?	
	Low Security	High Security
<b>General Settings</b>		
Clear the Event Log	NO	NO
Change the Screen Saver	YES	NO
Change the Sound Volume	YES	NO
Change the System Time	YES	NO
Reset all Settings	NO	NO
<b>Pressure Settings</b>		
Change or Reset Pressure Units	YES	NO
<b>Calibration Settings</b>		
Barometer Calibration	NO	NO
Auto-Calibration	NO	NO
<b>Test Management</b>		
Make a New Test	YES	NO
Edit or Change a Test	YES	NO
Delete a Test	YES	NO

Change the security level as follows:

1. From the Main menu, select **Settings** to open the settings menu.
2. Select the **Preferences** tab.
3. Select a security level.
4. Select **OK** to save and close the menu.

### **Sounds and Alarm Volume**

The Controller uses different sounds to audibly notify the user of actions on the Controller (see Table 2-4). The volume of the sound is user configurable and can be adjusted in the settings menu to Off, Low, Medium, or High.

*Note*

*Setting the volume to Low or Off does not disable the audible alarm.*

**Table 2-4. Sounds**

Action	Sound
Valid Key Push	High frequency, single beep
Invalid or Incorrect Key Push	Low frequency, single beep
Leak Check Complete	Three high frequency, single tones

The Controller has a loud audible alarm that sounds when an overpressure or a limit is exceeded (see Table 2-5). The alarm is not a general sound and sounds regardless of the volume settings.

**Table 2-5. Alarms**

Action	Sound
Upper or Lower Limit Exceeded	Continuous high frequency, single beeps until acknowledged
Overpressure	Eight second, high-frequency tone

Change the sound volume as follows (see Figure 2-13):

1. Select **Settings** on the Main menu.
2. Select the **Preferences** tab.
3. Select **Sound** to open the sound menu.
4. Select a volume level.

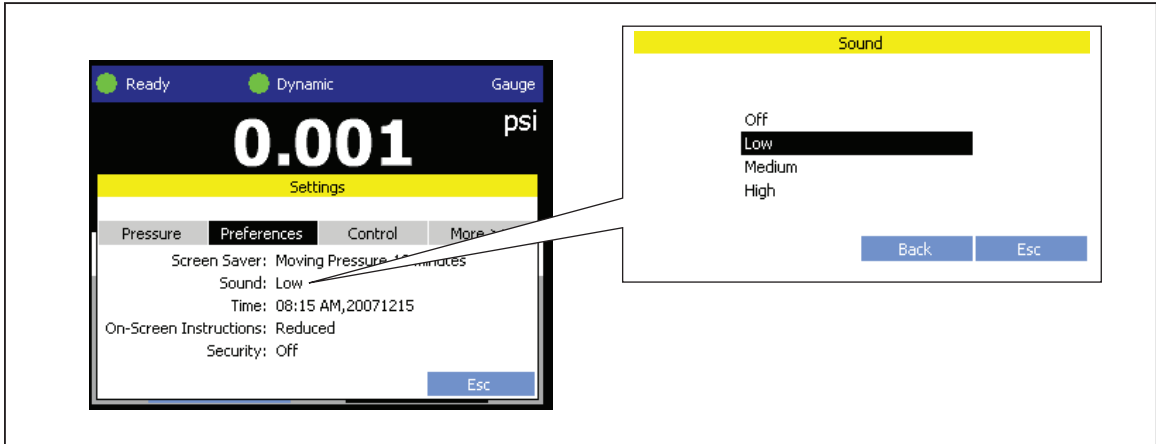

Figure 2-13. Sound Menu

gxj066.eps

# Chapter 3

## Controller Operation

Title	Page
Introduction.....	3-3
Turn On the Controller .....	3-3
Operating Modes.....	3-3
Warm-up .....	3-3
Common Navigation Buttons .....	3-4
The Main Menu .....	3-4
Set and Control Pressure.....	3-6
Set Target Pressure .....	3-8
Interrupt Pressure Control .....	3-8
Pressure Control Modes .....	3-8
Dynamic Control Mode.....	3-9
Dynamic Control Mode with Jog Approach .....	3-10
Static Control Mode .....	3-11
Set the Pressure Limits and Control Limits.....	3-12
Pressure Limits (Upper and Lower) .....	3-12
Control Limits (Hold and Stability) .....	3-13
Pressure Control Functions.....	3-14
Jog Step Pressure Up or Down.....	3-14
Vent the Controller.....	3-15
Abort for Emergency Pressure Relief .....	3-15
Measurement Settings and Limits.....	3-16
CalCheck Function .....	3-16
AutoZero and BaroCheck.....	3-16
Measurement Indicator .....	3-18
Measurement Modes .....	3-18
Measurement Resolution .....	3-19
Unit of Measure.....	3-20
UUT Tolerance Limit .....	3-22
Controller Tools.....	3-22
System Purge .....	3-22
Hose Purge.....	3-23
Leak Test .....	3-24
Exercise .....	3-25
Test a UUT.....	3-26
The Test Menu.....	3-27
Test Sequences .....	3-28
Test Sequence Actions .....	3-28
Find a Saved Test.....	3-29

Edit a Test .....	3-29
Copy a Test .....	3-29
Delete a Test.....	3-29
Make a New Gauge/Transducer Test.....	3-30
Make a New Pressure Switch Test.....	3-33
Run a Test Sequence .....	3-35
View Test Results .....	3-37
Print a Test Report .....	3-38

## Introduction

This chapter contains instructions on how to operate the Controller.

## Turn On the Controller

To turn on the Controller, connect the mains power cord and toggle the switch to the (I) position. The system initializes and a system startup screen shows the model number, serial number, and firmware version.

After the start-up initialization is complete, the startup screen disappears and the Operating Mode Selection menu opens and prompts the operator choose to use the Normal or Advanced operating mode (see Figure 3-1 and refer to “Operating Modes”).

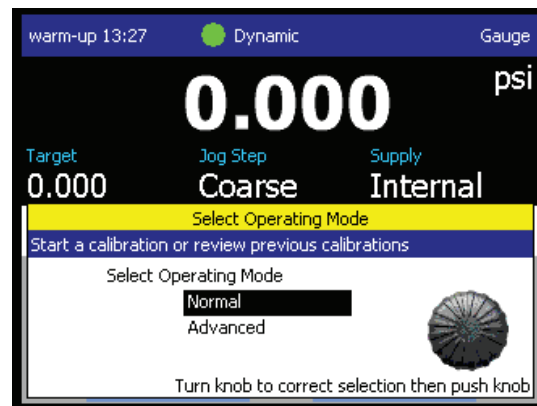

Figure 3-1. Startup Screen Example

gxj027.eps

## Operating Modes

The Controller has two operating modes:

- The **Normal** operating mode opens a simplified test menu that lets the operator quickly test a UUT. In the simplified test menu, the on-screen instructions guide the operator through setting up or selecting a test and running it in minimal time. When the test is finished, the operator can quickly review and print the test results. In the Normal mode, the operator still has the ability to use the Controller tools such as System or Hose Purge, Leak Test, and Exercise as part of the test sequence. This chapter does not provide instructions on how to step through the guided test, but does provide specific guidance on pressure control and measurement settings contained in the Normal operating mode.
- The **Advanced** operating mode opens the Main menu where the operator can choose from a variety of on-screen functions and menus such as the Test and Settings menus. See “The Main Menu” for more information on the menus and features that can be opened from the Main menu. This chapter provides guidance and information on the different settings and parameters that can be adjusted from the Main and subsequent menus and also how to test a UUT using the Advanced operating mode.

## Warm-up

For the Controller to perform to the specifications listed in Chapter 1, a 15 minute warm-up period is required after the Controller is turned on (additional ambient temperature acclimation may be required, see “Warm-up” in the Specifications section in Chapter 1). When turned-on, a countdown timer appears in the upper left corner of the main menu that shows the remaining warm-up time (see Figure 3-1). The countdown timer will disappear after the 15 minute warm-up is complete.

## Common Navigation Buttons

To navigate the menus, use the on-screen navigation buttons on the bottom of each menu. See Table 3-1 for information and a list of the common navigation buttons found on most menus. To move around the menus, use the Dual-Purpose Push Button/Rotary Dial or the **▲** or **▼** keys. To make a selection, push the Dual-Purpose Push Button/Rotary or **ENTER**. See “Controller Indicators and Controls” in Chapter 1 for more information on each key.

Table 3-1. Navigation Buttons

Button	Navigation Function
<b>OK</b>	Saves changes and navigates to the next menu.
<b>Back</b>	Cancel changes on current menu and navigates back to the last menu.
<b>Esc</b>	Cancel all changes and navigates back to the Main menu.

## The Main Menu

The Main menu is where all functions and menus are accessed. Refer to Table 3-2 for information about each item.

*Note*

*Most items on the Main menu are selectable and opens the related user-configurable options and settings.*

Table 3-2. Main Menu

Item	Name	Function
①	Measured Pressure	Shows the current applied pressure to the UUT and opens a menu that contains resolution settings from 1.0 to 0.0001 % of reading.



**Table 3-2. Main Menu (cont.)**

Item	Name	Function
②	Measurement Indicator	Shows when the pressure is stable and ready for a measurement. The indications are: (Green) Ready, (Yellow) Near Ready, (Red) Not Ready. This area also shows important notifications such as the warm-up countdown and also the Cal Check indicator if there is an issue with a module. See “Warm-up” on page 3-3 and “CalCheck Function” on page 3-16. See “Measurement Indicators” on page 3-22.
③	Pressure Control Mode	Shows the active control mode and opens a menu to configure the control mode parameters. The indications are: Dynamic, Dynamic: jog approach, and Static. When pressure control is active, the indicators are animated. See “Pressure Control Modes” on page 3-8.
④	Measurement Mode	Shows the active measurement mode and opens a menu to change the measurement mode. See “Change the Measurement Mode” on page 3-16.
⑤	Unit of Measure	Shows the unit of measure and opens a menu to change the unit of pressure. See “Make or Change a Unit of Measure” on page 3-20.
⑥	Supply	Opens a menu to set the default pressure source for targets between 4 and 305 psig. See “Set the Internal and External Supply Setting” in Chapter 2.
⑦	Head-height Correction	Shows the current head-height correction and opens a menu that contains user-configurable settings for head height, units, and type of gas in use. See “Make a Head-Height Correction” in Chapter 2.
⑧	Exercise	Opens a menu to configure and exercise a UUT. See “Exercise” on page 3-25.
⑨	Settings Menu	Opens a two-page settings menu to configure the Controller. See “The Settings Menu” in Chapter 2.
⑩	Test Menu	Opens the test menu to configure and perform a test on a UUT. See “About the Test Menu” on page
⑪	Leak Test	Opens a menu to configure and perform a leak test on the system. See “Leak Test” on page 3-27.
⑫	System Purge	Opens a menu to configure and purge the plumbing in the Controller. See “System Purge” on page 3-22.
⑬	Hose Purge	Opens a menu to configure and purge a hose. See “Hose Purge” on page 3-23.
⑭	Instructions	Shows helpful on-screen instructions. This can be set to Normal or Reduced. See “The Settings Menu” in Chapter 2.
⑮	Target Pressure	Shows the current target pressure value and opens a menu to set a target pressure. See “Set Target Pressure” on page 3-6.
⑯	Jog Step	Shows the Jog Step setting. The two Jog Step settings are Coarse and Fine. See “Jog Step Pressure Up or Down” on page 3-14.

## Set and Control Pressure

To measure pressure, the Controller uses four Pressure Transducer Modules (pressure module). A pressure module (shown in Figure 3-2), is a serviceable and replaceable pressure measurement component installed behind the display. It allows for easy access to calibrate or replace a failed pressure module. Each pressure module has an assigned slot with a specific pressure range.

### Caution

**To prevent damage to the pressure modules, turn off power prior to removal and installation.**

The Controller reads the pressure module information and checks each pressure module on Controller startup. If a pressure module is out of tolerance or in the incorrect slot, the Controller shows an error on the Startup screen and pressure control is disabled until the condition is corrected.

Each pressure module has three internal sensor elements that make three separate measurements. The output of all three sensors are averaged to reduce total measurement uncertainty. The three individual measurements are also constantly monitored and compared against each other to ensure that they are indicating pressure within a certain tolerance of each other. If one of the sensor elements measure a value that is unlike the other two sensor elements measurements, the Controller shows “CalChk” on the top of the Main menu to provide early warning of a potential out of tolerance condition (see “CalCheck Function” on page 3-16).

Each pressure module is calibrated individually against an external reference. See the calibration procedure in Chapter 7 or in the *4322 Service Manual* for calibration instructions.

Use the information in the subsequent sections to set pressure, define limits, and perform pressure functions.

A similar replaceable barometer module (shown in Figure 3-2), provides reference pressure measurement over the barometric range. During normal use, the barometer module reads atmospheric pressure through the ATM port on the front panel of the Controller, and is not exposed to the pressure excursions seen by the pressure modules. This limited use further improves the performance of the barometer module, providing stable measurements for the AutoZero and BaroCheck functions (see “AutoZero and BaroCheck” on page 3-16. The barometer is a serviceable and replaceable module that must be regularly calibrated.

Read the subsequent sections for more information on the measurement indicators and measurement modes. Refer to the *4322 Service Manual* for maintenance time intervals, calibration procedures, and replacement instructions.

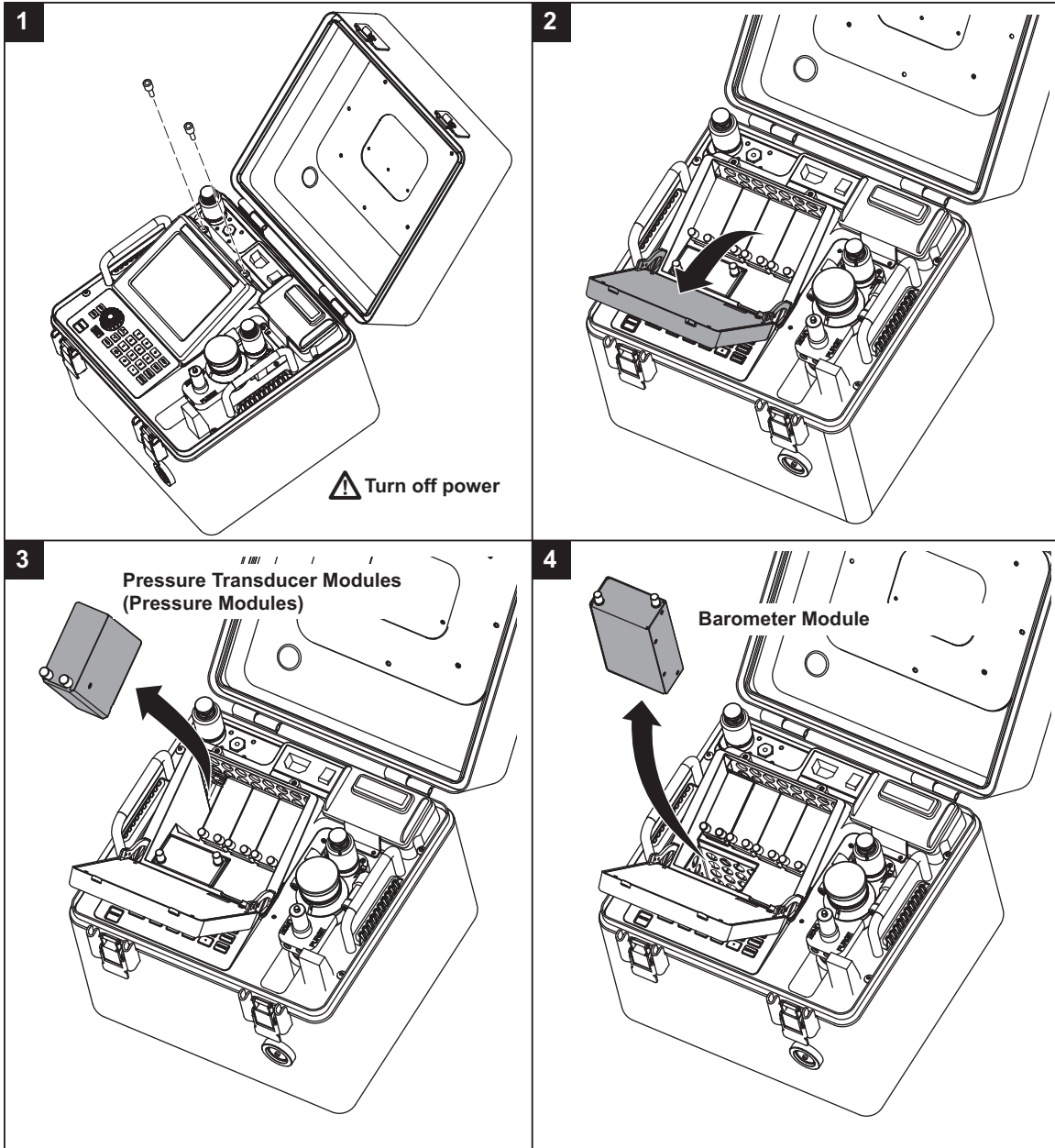

Figure 3-2. Pressure Transducer Modules and Barometer Removal

gxj079.eps

## Set Target Pressure

Target pressure is the numerical pressure value the Controller controls pressure to when commanded. When a target pressure is set, the Controller opens the internal pressure valves and applies pressure to the UUT. As the pressure approaches the target value, pressure control slows to prevent an overshoot. The Controller then uses the active control mode to keep the pressure between the upper and lower hold limits (see “Pressure Control Modes” on page 3-8).

### Note

*If the Controller is unable to control pressure or controls pressure poorly, see the troubleshooting procedures in Chapter 4.*

Set the Target Pressure as follows (see Figure 3-3):

1. Select **Target** in the Main menu or push **SET P** on the control panel to open the Set Pressure menu.
2. Enter the Target Pressure.

### Note

*The upper and lower pressure limits are shown for reference on the menu. A target pressure entry that exceeds the current upper limit or that is out of range will not be accepted as the target value. To change the limits, see “Pressure Limits (Upper and Lower)” on page 3-12.*

3. Push **OK** to start pressure control to the target pressure value.
4. When pressure control is active, use **▲** and **▼** to change the target pressure.

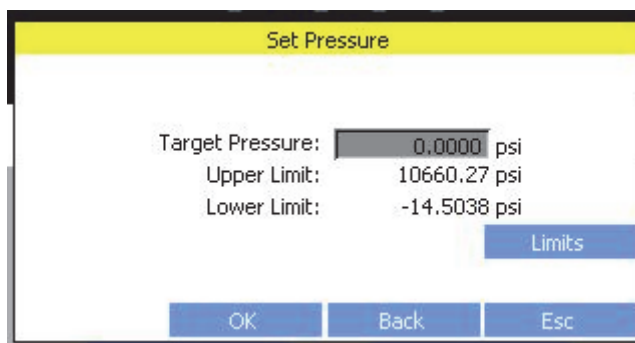

Figure 3-3. Set Target Pressure

gxj065.jpg

## Interrupt Pressure Control

When pressure control is active, if **ESC** or **SET P** is pushed, the Controller pauses pressure control and returns to the Main menu. The pressure is not vented from the system. To resume pressure control, push **SET P** and enter a target pressure then push **OK**.

To quickly stop pressure control and immediately vent pressure, push **ABORT** or **VENT**.

## Pressure Control Modes

The Controller offers three different control modes to set pressure: Static Mode sets the target pressure and stops controlling, adjusting only when the measured pressure has exceeded specific limits. Dynamic Mode sets the target pressure and constantly adjusts to maintain the target. Dynamic Control with Jog Approach uses the same control as Dynamic Mode, but pressure is set to a point short of the test point. The user then uses the jog function to adjust pressure to the desired UUT reading.

The control mode to be used is selected in the settings and also as part of a test. When a

target pressure is set on the Main menu, the Controller uses the control parameters found in the control settings menu in the settings. If a test is run, the Controller uses the control parameters selected and saved in the test setup.

The two modes have similar control parameters but control pressure differently (see “Pressure Control Parameters, limits, and Functions”). Read the subsequent sections for more information on each mode.

Change the Pressure Control Mode as follows (see Figure 3-4):

From the Main menu:

1. Select the **Control Mode Indicator**.
2. Select **Dynamic** or **Static**.

Through the Settings menu:

1. Select **Settings** on the Main menu then select the Control tab.
2. Select **Pressure Control** to open the control mode settings.
3. Select **Dynamic** or **Static**.

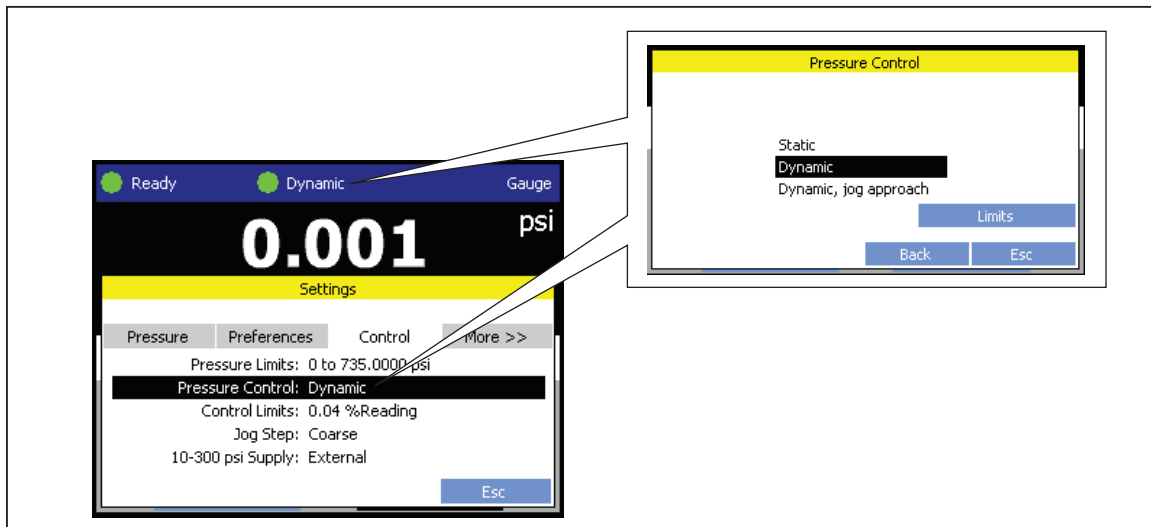

Figure 3-4. Control Mode Settings

gxj046.eps

### Dynamic Control Mode

Dynamic Control sets the pressure to the target value then continuously controls pressure to keep it at the target value (see Figure 3-5). Dynamic Control is beneficial for most applications because it automatically compensates for changes to the system from adiabatic affects and small leaks. Dynamic Control is the default control mode when the Controller is turned on and shows in the user interface as ● **Dynamic**.

#### Note

*Dynamic Control generates a very small amount of pressure noise due to continuous pressure control. The pressure noise is undetectable in most UUTs. For high-end sensitive UUTs where pressure noise is a concern, use Static Control for the test.*

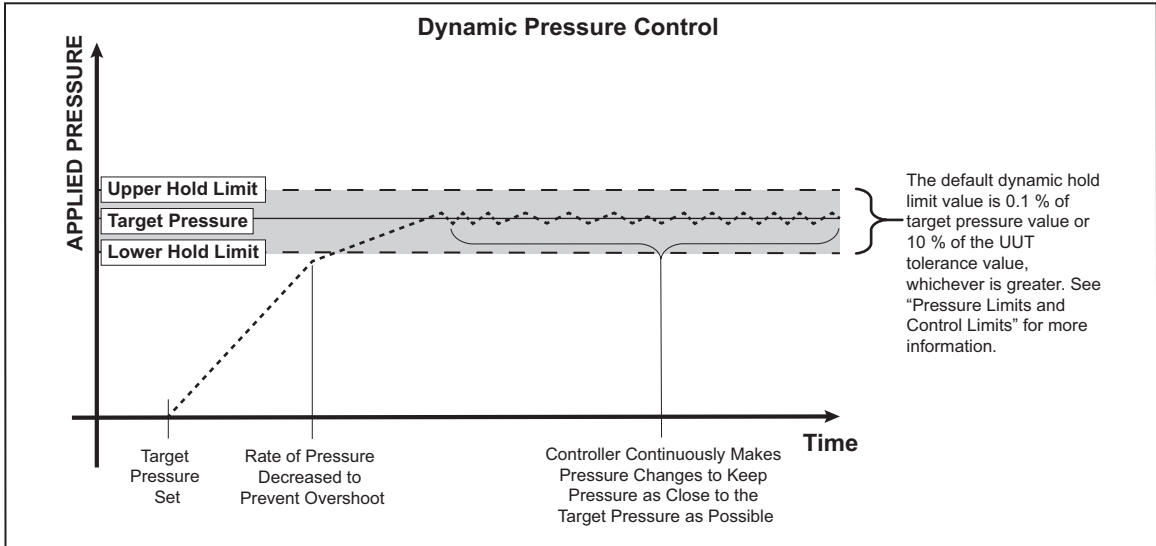

Figure 3-5. Dynamic Pressure Control Mode Example

gxj011.eps

### Dynamic Control Mode with Jog Approach

Dynamic Control with Jog Approach stabilizes the pressure at the target pressure and then prompts the user to manually Jog the pressure to the set test point (see Figure 3-7). For this mode and test, the user watches the UUT reading to visually set the pressure to the test point.

This mode allows the user to manually set the pressure. As a result, it prevents UUT reading interpolation and/or pressure overshoot. This is commonly known as a “Cardinal Point” calibration, and is useful for calibration of analog dial gauges.

The 4322 has more resolution than the UUT and allows the set point to be adjusted up or down so that the UUT pressure gauge needle is aligned on top of a cardinal mark. This mode is the default setting for tests with the Pressure Gauge UUT Type selected and shows in the user interface as **Dynamic with Jog Approach**.

When the test is run, the Controller controls and stabilizes the pressure slightly above or below the test set point pressure (above for descending test points, below for ascending test points). The amount of pressure above or below the test set point is calculated as follows:

**Ascending Target** = Test Point Pressure – (2 x UUT Tolerance Value)

**Descending Target** = Test Point Pressure + (2 x UUT Tolerance Value)

After the pressure is stable, the Controller prompts the user to Jog up or down to the test set point (see Figure 3-6). The user turns the rotary dial or pushes the **▼** and **▲** keys to set the pressure to the set test point and make a measurement. This procedure is then repeated for every test point for the remainder of the test.



Figure 3-6. Jog To Approach

gxj021.jpg

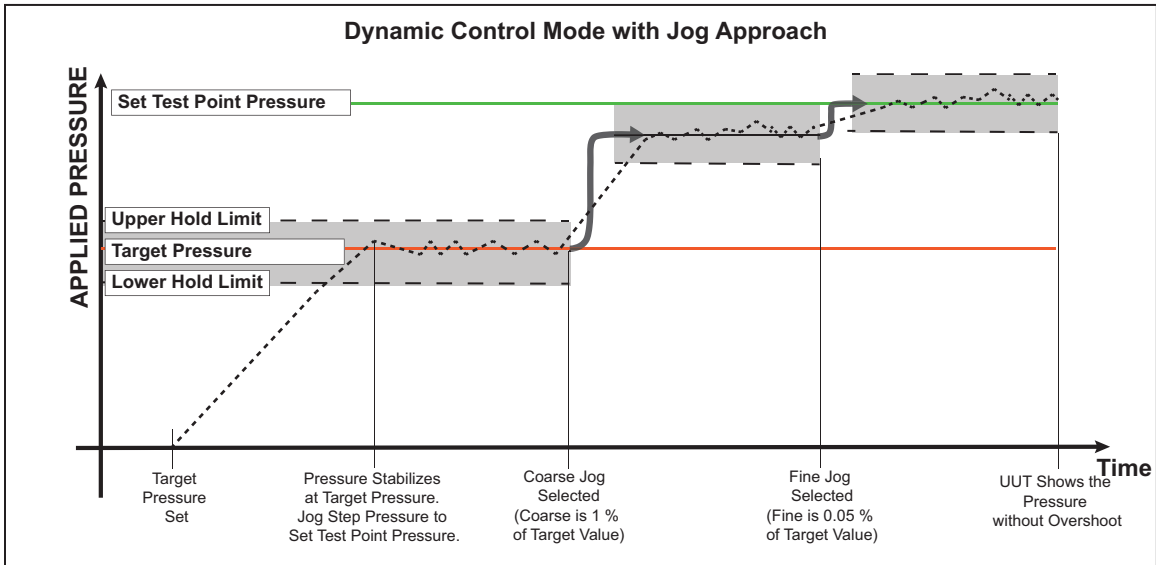

Figure 3-7. Dynamic Control Mode with Jog Approach Example

gxj018.eps

### Static Control Mode

Static Control sets the pressure slightly above the target pressure value then turns off active pressure control (see Figure 3-8). The pressure is allowed to naturally settle until it exceeds the lower or upper hold limit. When the pressure exceeds a hold limit, the Controller resets the pressure slightly above the target pressure value then turns off active pressure control again to reestablish pressure within the hold limits. This pressure control sequence repeats until the target pressure is changed or the test is complete.

The advantage of this control mode is that pressure can be set and measured without noise from the pressure control system. Static Control shows in the user interface as **○ Static**. A **● Ready** indication is predicated on pressure being inside the hold limits and the rate of change of pressure is less than the stability limit.

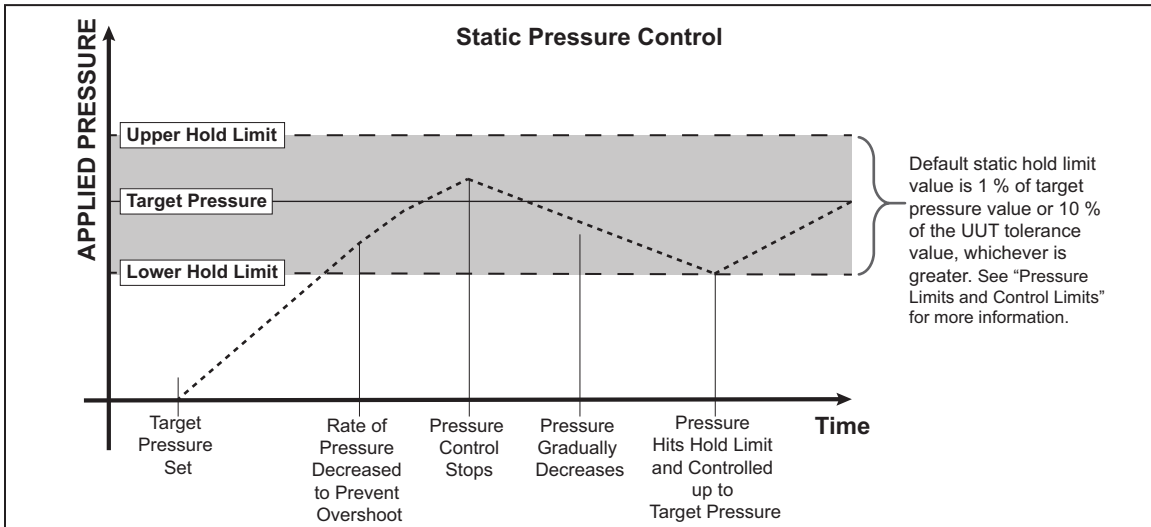

Figure 3-8. Static Pressure Control Mode Example

gxj017.eps

### Set the Pressure Limits and Control Limits

Pressure control limits are user configurable settings the Controller uses to make sure that applied pressure does not exceed the operator defined limitations. Control parameters are configured in the settings menu and also in the test menu.

*Note*

*Control parameters are set in the settings and also in the Test Sequence parameters. When a test is run, the Controller reads the settings in the test file and temporarily changes the settings to the settings contained in the test. After the test is complete, the Controller automatically reverts back to the settings that were set before.*

See the subsequent sections for more information on each control limit.

### Pressure Limits (Upper and Lower)

The upper and lower pressure limits are user configurable pressure limits that protect the UUT from accidental overpressure. The limits are used when the target pressure is manually set from the Main menu. If the target pressure keyed in is more than the upper limit or less than the lower limit, the Controller will not accept the target pressure value and displays an out of range error message.

*Note*

*When a Test Sequence is run, the Controller automatically vents excess pressure to protect the UUT if pressure greater than 110 % of the UUT full scale range is sensed. No manual setting of upper limit or other settings is necessary to engage this protection.*

Change the Upper and Lower Pressure Limits as follows (3-9):

1. Select **Settings** on the Main menu.
2. Select the **Control** tab.
3. Select **Pressure Limits** to open the pressure limits menu.
4. Set the **Upper** and **Lower Pressure Limits** for the UUT.
5. Select **OK** to save and close the menu.

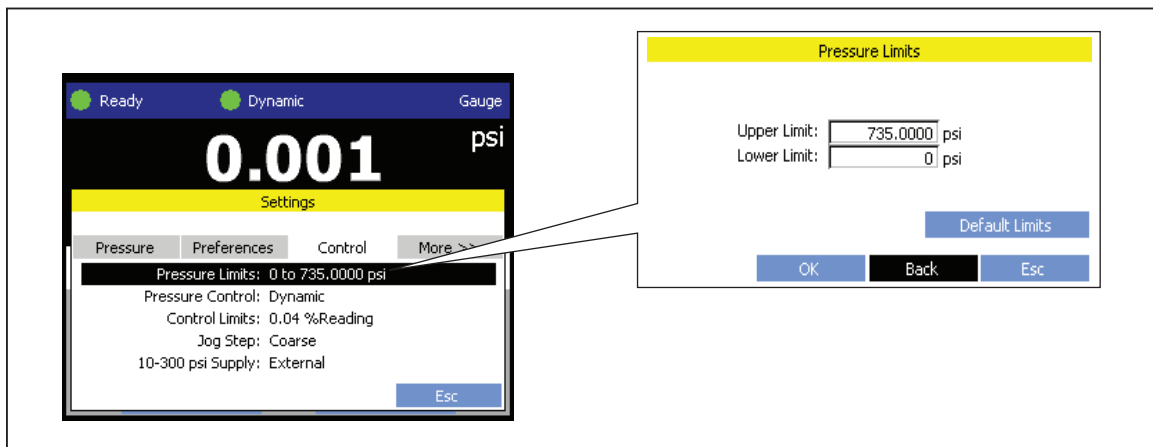

Figure 3-9. Pressure Limits

gxj056.eps



**Control Limits (Hold and Stability)**

The control hold limit is a symmetrical positive and negative range of pressure above (upper limit) and below (lower limit) the target pressure (see Figures 3-5, 3-6, and 3-8). The Controller does not let the applied pressure go outside the hold-limit range. The hold limit is used to determine **Ready** in dynamic control mode. Static control mode uses a combination of the hold limit and stability limit to determine **Ready**. The hold-limit ranges are different for each mode (See Table 3-3).

**Table 3-3. Hold limits**

Control Mode	Value in Settings	Value in Test
Dynamic Control	Default dynamic hold limit value is 0.1 % of target pressure value. This percentage can be changed in the settings menu. <b>Example:</b> The upper and lower dynamic hold limit for a target value of 6,000 psi is 6 psi (6,000 psi x 0.1 % = 6 psi). The Controller keeps the pressure stable between 5,994 psi and 6,006 psi.	Current value in settings or 10 % of the UUT tolerance value, whichever is greater.
Dynamic Control Mode with Jog Approach	Default dynamic with approach hold limit value is 0.1 % of reduced target pressure value. This percentage can be changed in the settings menu. <b>Example:</b> The upper and lower dynamic with approach hold limit for a reduced target value of 6,000 psi is 6 psi (6,000 psi x 0.1 % = 6 psi). The Controller keeps the pressure stable between 5,994 psi and 6,006 psi. Each time Jog Step is pushed, the pressure increases and the hold limit increases with it (see Figure 3-7).	
Static Control	Default static hold limit value is 1 % of target pressure value. This percentage can be changed in the settings menu. <b>Example:</b> The upper and lower static hold limit for a target value of 6,000 psi is 60 psi. (6,000 psi x 1 % = 60 psi). The Controller keeps the pressure stable between 5,940 psi and 6,060 psi.	

The stability limit is a rate of pressure change limit used to tell if the pressure has stabilized enough to make a measurement. If the pressure is within the stability limits, the Controller changes the Measurement Indicator to **Ready**. See Table 3-4 for the stability limits.

**Table 3-4. Stability Limits**

Value in Settings	Value in Test
The default Stability Limit value is 0.1 % of target pressure value change per second. This percentage can be changed in the settings menu. <b>Example:</b> The Stability Limit for a target value of 6,000 psi is 6 psi/second (6,000 psi x 0.1 % = 6 psi).	Current value in settings or 10 % of the UUT tolerance value, whichever is greater.

Change the Control Limits as follows (see Figure 3-10):

1. From the Main menu, select **Settings** to open the settings menu.
2. Select the **Control** tab.
3. Select **Control Limits** to open the control limits menu.
4. Set the **Hold Limit**. The hold limit is a pressure range above and below the target pressure. The Controller keeps the pressure within the range when in dynamic mode.
5. Set the **Stability Limit**. The stability limit is a stability setting that is set to determine if the pressure is stable enough to make a measurement.
6. Select **OK** to save and close the menu.

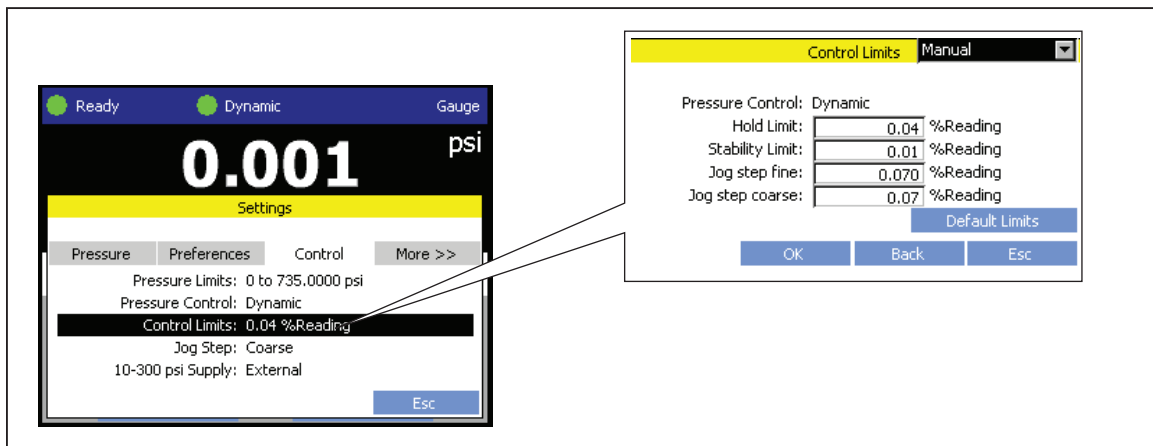

Figure 3-10. Control Limits

gxi055.eps

### Pressure Control Functions

Read the subsequent sections for instructions on how to use the three pressure control functions: jog, vent, and abort.

### Jog Step Pressure Up or Down

Jog Step is a pressure control function that increases or decreases pressure incrementally. The Jog Step can be set to be a Fine step or Coarse step (see Table 3-5 for fine and coarse parameters).

To Jog Step pressure, push **▼** and **▲** on the control panel when pressure control is active. Push **STEP** to change between Fine and Coarse.

**Table 3-5. Jog Step Parameters**

Control Mode	Value in Settings	Value in Test
Fine Jog Step	The default Fine Jog Step value is 0.05 % of target pressure value. This percentage can be changed in the settings menu. <b>Example:</b> A Fine Jog Step for a target value of 6,000 psi is 3 psi (6,000 psi x 0.05 % = 3 psi). Each time Fine Jog Step is pushed, the pressure increases or decreases 3 psi.	Current value in settings or 5 % of the UUT tolerance value, whichever is greater.
Coarse Jog Step	The default Jog Step value is set to 1 % of target pressure value. This percentage can be changed in the settings menu. <b>Example:</b> A Coarse Jog Step for a target value of 6,000 psi is 60 psi. (6,000 psi x 1 % = 60 psi). Each time Coarse Jog Step is pushed, the pressure increases or decreases 60 psi.	Current value in settings or 1 % of the UUT tolerance value, whichever is greater.

Change Between Coarse and Fine as follows:

Push **STEP** on the Control Panel or the Handheld Controller when pressure is dynamically controlled.

-- or --

From the Main menu:

1. Select the **Jog Step Indicator**.
2. Select **Coarse** or **Fine**.

Change the Jog Step Parameters:

1. From the Main menu, select **Settings** to open the settings menu.
2. Select the **Control** tab.
3. Select **Control Limits** to open the control limits menu.
4. Set the **Jog Step Fine**.
5. Set the **Jog Step Coarse**.
6. Select **OK** to save and close the menu.

### *Vent the Controller*

The **VENT** key on the control panel completely vents applied pressure at a controlled rate when pushed. If **VENT** is pushed when a test is in progress, the test immediately stops and Controller vents all pressure in the system.

### *Abort for Emergency Pressure Relief*

For emergency pressure relief, the red **ABORT** key immediately vents all pressure and cancels the test. When the red **ABORT** key is pushed, the Controller closes any open menus and returns to the Main menu.

The Controller has an automatic pressure relief function that releases pressure if it exceeds the upper or lower pressure limits. If an over pressure occurs, the Controller sounds an alarm for 8 seconds, aborts the test, and logs an event in the Event Log (see “Event Log” in Chapter 4). In addition, if the display is rotated to access the Pressure Transducer Modules and pressure control is active, the Controller performs an automatic emergency pressure relief to protect the user.

To recover from an over pressure, correct the over pressure condition and then cycle Controller power.

*Note*

*When a Test Sequence is run, the Controller automatically vents excess pressure to protect the UUT whenever pressure greater than 110 % of the UUT full scale range is sensed. No manual setting of upper limit or other settings is necessary to engage this protection.*

## Measurement Settings and Limits

The Controller relies on multiple sensors to not only improve measurement performance, but also to detect potential failure or out of tolerance conditions before erroneous measurements are performed.

### CalCheck Function

Each pressure module features three redundant pressure sensing elements. Measurement uncertainty is reduced during normal operation by averaging the output of the three elements to determine the final pressure measurement used by the Controller. The Controller also monitors the individual pressure measurement of the elements and compares them to each other. If one of the elements does not agree with the other two within expected limits, the Controller will display an on-screen CalCheck alert. In addition to the alert, a “CalChk” notification indicating the range of the suspect pressure module will appear in the upper left portion of the Main menu over the Ready Indicator until the issue is resolved (the indicator flashes on and off every 2 seconds). The CalChk indicator can be selected to view the original on-screen error message (see Figure 3-11). The CalCheck feature is performed constantly and transparently to the operator. Action is only required if the CalChk indicator is displayed.

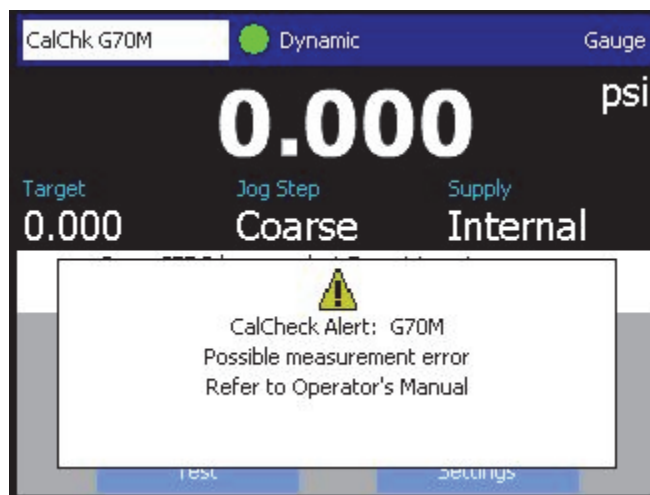

Figure 3-11. CalCheck Indicator

gxj061.jpg

### AutoZero and BaroCheck

During normal use, the barometer module reads atmospheric pressure through the ATM port on the front panel of the Controller, and is not exposed to the pressure excursions seen by the pressure modules. This limited use and the intrinsic measurement characteristics of the barometer module offer a very stable reference pressure for measurement assurance features. A direct reading of atmospheric pressure also allows the Controller to determine gauge pressure with the intrinsically absolute pressure module and to measure absolute pressure with the gauge pressure modules.

The AutoZero feature compares the active pressure module output to the internal atmospheric pressure reference, tares the difference and in some modes dynamically compensates for changes in atmospheric pressure. The function happens automatically

and seamlessly during every vent operation after the Controller has determined that pressure measurement is fully vented and stable.

- Gauge pressure measurement with intrinsically gauge pressure modules (G700K, G10M, G70M): AutoZero tares the reading to zero gauge pressure at vent.
- Absolute pressure measurement with intrinsically gauge pressure modules (G700K, G10M, G70M): AutoZero tares the reading to zero gauge pressure measurement at vent. For all subsequent measurements, the output is dynamically compensated to indicate absolute pressure by adding the outputs of the active gauge pressure module and the barometer module.
- Gauge and vacuum pressure measurement with the intrinsically absolute pressure module (A150K): AutoZero tares the reading to zero gauge pressure at vent. At all other pressures, the output is dynamically compensated for small changes in atmospheric pressure measured by the barometer module.
- Absolute pressure measurement with the intrinsically absolute pressure module (A150K): AutoZero tares the absolute pressure reading to align with the barometer module at vent. This tare is used for all subsequent measurements until the next vent routine.

The BaroCheck feature also utilizes the stability of the barometer module to ensure measurement performance at low pressure. The BaroCheck function compares the outputs of the A150K pressure module and the barometer module at several points in the atmospheric pressure range. If the pressure modules agree within the expected tolerance, the BaroCheck function will compensate the output of the A150K pressure module by the difference. If the pressure modules do not agree within the expected tolerance, one of the components may be failing or exceeding measurement tolerance, so compensation will not be applied and the Controller will alert the user to a potential measurement issue.

The BaroCheck function is recommended to be run at least once every 30 days. The Controller keeps track of when BaroCheck has been run, and will indicate if 30 days has been exceeded with a “BaroChk” indication in the top left of the Main menu.



The BaroCheck function can be performed by selecting “BaroCheck” under the Calibration tab in the Settings Menu while in Advanced Mode. If the user selects to run a test procedure or perform a calibration while the Controller is displaying the BaroCheck indication, the operator will be prompted to first perform the BaroCheck routine. If more than 35 days has passed since the last successful BaroCheck routine, the Controller will force BaroCheck to be performed before proceeding with a test procedure or calibration.

Once initiated, the BaroCheck runs automatically. As the BaroCheck function runs, the Controller prompts the user to cap the test port and asks to proceed. The Controller shows that BaroCheck is in progress for approximately 15 to 45 minutes as it automatically sets several test points and verifies measurement. The variation in time needed to complete BaroCheck is influenced by the Controller temperature stability which is affected by how the system has been warmed up and used prior to running BaroCheck. In some cases, the process can take up to an hour. The Controller beeps three times at the conclusion of the test to alert that the function is complete. When BaroCheck detects damage or an out of tolerance condition, the Controller notifies the user to run the BaroCheck function again or to check calibration of the A150K and barometer modules.

### Measurement Indicator

The Measurement indicator (also known as the “Ready indicator” in previous products) is a visual indicator that shows when the pressure is stable enough to make an accurate measurement. See Table 3-6 for a list of Measurement Indicators and their definition. For the indicator to change to **Ready**, the rate of pressure change has to be within the stability limits and the pressure needs to be inside the hold-limit range for the active pressure control mode. See “Pressure Limits (Upper and Lower)” on page 3-12.

**Table 3-6. Pressure Status Indicator**

Indication	Handheld Control Indication	Definition
<b>(Red) Not Ready</b>	NR 	Indicates that there is currently a high rate of pressure change and the pressure is not stable enough to make a measurement.
<b>(Yellow) Near Ready</b>	No Indication	Indicates that there is currently a medium rate of pressure change and the pressure is almost stable enough to make a measurement.
<b>(Green) Ready</b>	R 	Indicates that the pressure is stable and the rate of pressure change is within the stability limits. A measurement can be made.  <i>Note</i> <i>Ready shows when the Controller is vented to indicate that it is OK to make an ATM or 0 psig measurement.</i>

Here is an example that shows what indications will show at the different states of pressure control:

1. A target pressure is set, either on the Main menu or as a test point in a Test Sequence.
2. The Controller reads the target pressure and precisely controls two high-pressure valves to supply pressure to the UUT. When pressure is ramping towards the target, the measurement indicator shows **Not Ready**.
3. As the pressure builds, the Controller measures the applied pressure and reports the rate of pressure change. As the applied pressure approaches the hold limit, the Controller decreases the rate of pressure change to prevent a target pressure overshoot. When the pressure starts to stabilize near the target pressure, the measurement indicator changes to **Near Ready**.
4. The Controller continues to decrease the rate of pressure change as the applied pressure gets closer to the target pressure. If the pressure is within the hold limits, the measurement indicator changes to **Ready** and a measurement can be made.

### Measurement Modes

The Measurement Mode is a user configurable setting that sets the Measurement Mode. The three Measurement Modes are Absolute, Gauge, and Vacuum.

- **Absolute** mode adds barometric pressure to the measured gauge pressure to get an equivalent absolute pressure. Absolute can never be shown as a negative value.
- **Gauge** mode uses pressure modules to measure positive pressure (relative to atmosphere).
- **Vacuum** mode uses pressure modules to measure negative gauge pressure (relative to atmosphere).

*Note*

*The Controller displays vacuum pressures as negative values (for example, -9.32 psig). Some vacuum gauges do not show a negative sign (-) in front of the reading because they are used for only vacuum measurements (the vacuum gauge would show “9.32 psi vacuum” without the negative sign). To prevent misinterpretation of the vacuum gauge reading compared to the negative value on the Controller, look at the gauge face or user documentation to see how the vacuum gauge shows vacuum pressures.*

Change the Measurement Mode as follows (see Figure 3-12):

1. Select the **Measurement Mode Indicator** on the Main menu.
2. Select **Gauge, Absolute, or Vacuum.**

--OR--

1. Select **Settings** on the Main menu.
2. Select the **Pressure** tab.
3. Select **Measurement Mode** to open the control mode settings.
4. Select **Gauge, Absolute, or Vacuum.**

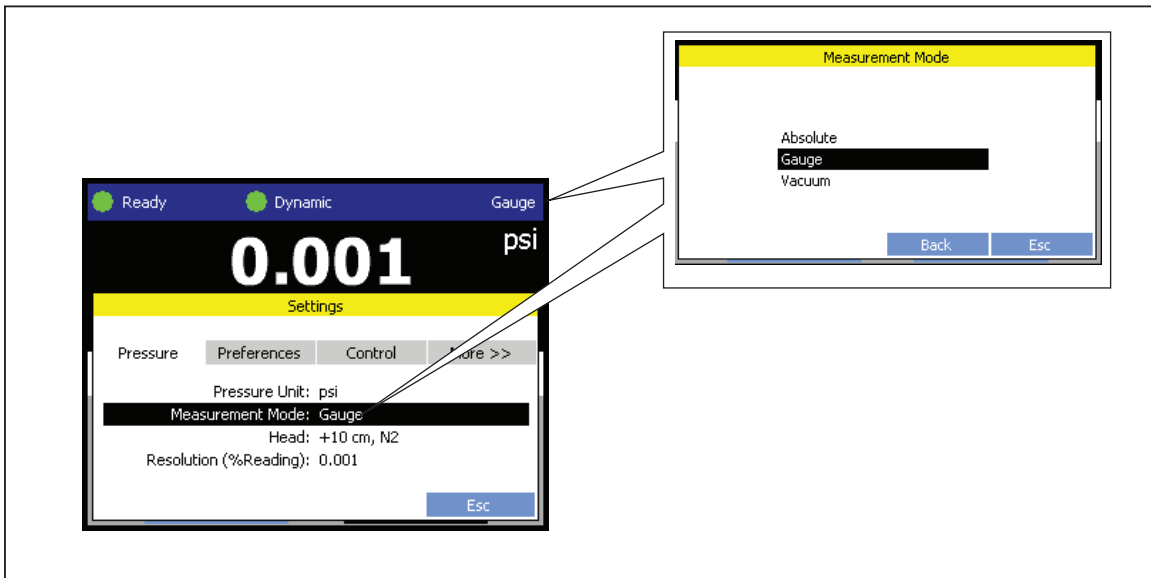

**Figure 3-12. Measurement Mode Settings**

gxj047.eps

**Measurement Resolution**

The Controller displays the measured pressure value. The Measurement Resolution selections are 1.0, 0.1, 0.01, or 0.001 % of reading. The statement “% of reading” means that the Controller multiplies the measured value by the resolution to determine how many digits to show. For example, if the actual measured value was 7,000.1234 psi and the resolution was set to 0.001, the Controller shows 7,000.1. The resolution limited to 1 % of measurement uncertainty across the entire range, with an ultimate minimum setting of 2.5 Pa (0.00004 psi).

Change the Measurement Resolution as follows (see Figure 3-12):

1. Select the **Measurement Indicator** from the Main menu.
2. Select **1.0, 0.1, 0.01, or 0.001**.
- or--
1. Select **Settings** on the Main menu.
2. Select the **Pressure** tab.
3. Select **Resolution (%Reading)** to open the resolution settings.
4. Select **1.0, 0.1, 0.01, or 0.001**.

### Unit of Measure

The Controller has a large selection of standard engineering units that can be selected to satisfy a large majority of calibration requirements. Sometimes, special calibrations require an uncommon or special unit of measure. These nonstandard units are referred to as user defined units. The Controller lets the user define up to five units to use and save for future use. Table 3-7 is a list of the selectable standard units and their descriptions.

**Table 3-7. Units of Measure**

Unit	Description	Unit	Description
ATM	Atmospheres	inSW20C	Inches of salt water at 20 °C
bar	Bar	kgcm2	Kilograms per square centimeter
cmHg0C	Centimeters of mercury	kgm2	Kilogram force per square meter
cmH2O20C	Centimeters of water at 20 °C	kgmm2	Kilogram force per square millimeter
cmH2O4C	Centimeters of water at 4 °C	kPa	Kilopascal
cmSW20C	Centimeters of salt water at 20 °C	ksi	kilopound per square inch
dyncm	Dynes per square centimeter	mbar	Millibar
ftHg0C	Feet of mercury	mHg0C	meters of mercury at 0 °C
ftH2O20C	Feet of water at 20 °C	mmH2O20C	Millimeters of water at 20 °C
ftSW20C	Feet of salt water at 20 °C	mmHg0C	Millimeters of mercury at 0 °C
gfc	Grams force per square centimeter	mmSW20C	Millimeters of salt water 20 °C
hPa	Hectopascal	MPa	Megapascal
inH2O4C	Inches of water at 4 °C	mTorr	MilliTorr
inH2O20C	Inches of water at 20 °C	osi	Ounces per square inch
inH2O25C	Inches of water at 25 °C	Pa	Pascal
inH2O60F	Inches of water at 60 °F	psf	Pounds per square foot
inHg0C	Inches of Mercury at 0 °C	psi	Pounds per square inch
inHg32F	Inches of mercury at 32 °F	Torr	Torr (also mmHg)
inHg60F	Inches of mercury at 60 °F		



Change the Unit of Measure as follows (see Figure 3-13):

*Note*

*If the Controller does not have a unit that the calibration requires, a custom measurement unit can be made. The custom unit is referred to as a “User Unit”. To make a User Unit, select the Create User Unit tab on the units menu and select a user defined unit. A menu will open that has settings to define a unit. The user unit is a number in relation to 1 Pa.*

1. Select **Unit of Measure indicator** on the Main menu to open the supply menu.
  2. Select a **Unit of Measure** from the list. Commonly used units are in the Favorites tab and all units are in the **All Units** tab. User Units are also listed in the **All Units** tab.
- OR--
1. From the Main menu, select **Settings** to open the settings menu.
  2. Select the **Pressure** tab.
  3. Select **Pressure Unit**.
  4. Select a **Unit of Measure** from the list. Commonly used units are in the Favorites tab and all units are in the **All Units** tab. User Units are also listed in the **All Units** tab.

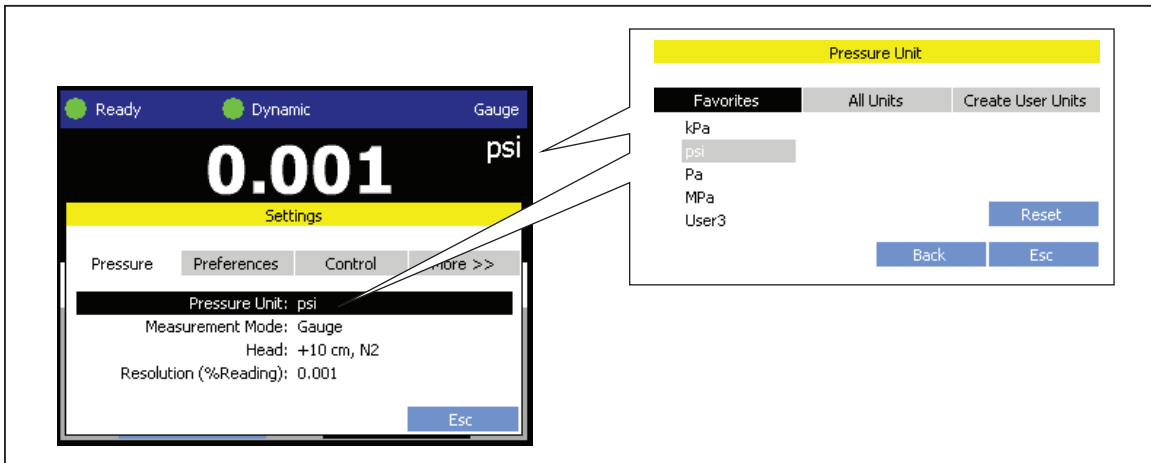
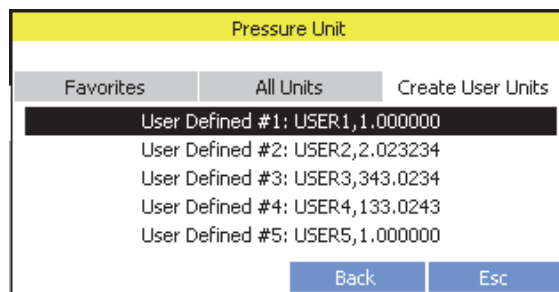

**Figure 3-13. Unit of Measure**

gxj048.eps

Make a Custom User Unit:

1. Open the **Pressure Unit** menu (see “Unit of Measure” in the previous procedure).
2. Select the **Create User Units** tab.
3. Select a **User Defined #** to edit.



4. Enter the **Unit Name**.

5. Enter the **Units/Pa**.

The screenshot shows a menu titled "User Defined #1" with a yellow header. Below the header, the text "Unit Name: USER1" is displayed. Underneath, "Units/Pa:" is followed by a text input field containing "1.000000". At the bottom right, there is a "Default" button. At the bottom center, there are three buttons: "OK", "Back", and "Esc".

### UUT Tolerance Limit

The UUT tolerance limit is the maximum anticipated deviation between the reading of the UUT and the measurement made by the Calibrator. After a test is complete, the Controller compares the UUT Tolerance limit against the actual test results. From the comparison, the Calibration report shows if a UUT passed or failed. UUT Tolerance limit is a mandatory test parameter when a test is setup.

### Controller Tools

The Controller includes a set of standard functions (tools) typically performed prior to calibration including a system purge, a hose purge, a leak test, and exercise a UUT. Read the subsequent sections for more information on each tool.

### System Purge

System Purge is a function of the Controller that pressurizes and vents the test system plumbing connected to the Controller. It is recommended to do a system purge before a calibration is performed to rid the system of contaminates when you expect that liquid or particulate contaminates are present. The Controller is designed to maintain internal cleanliness during any operation, but contaminates are most easily handled during a relatively low pressure purge. To purge the system, the Controller pressurizes to the user-defined purge pressure then immediately vents to the plastic waste container. The process will repeat for as many cycles that are set.

Purge the system as follows:

1. Connect the male end of the test hose to the female **TEST** port on the Controller.
2. Connect female end of the test hose to the male **QC adapter** on the UUT. If a test hose is not used, connect the male QC adaptor fitting of the UUT directly to the TEST port.
3. Navigate to and select **System Purge** on the bottom of the Main menu. A purge menu opens.

The screenshot shows a menu titled "System Purge" with a yellow header. Below the header, the text "Cycles:" is followed by a text input field containing "2". Underneath, "Purge Pressure:" is followed by a text input field containing "50.0000 psi". At the bottom center, there are three buttons: "OK", "Back", and "Esc".

4. Key the number of times to cycle into the **Cycles** field.
5. Key in the amount of pressure into the **Purge Pressure** field.

6. Select **OK**. The Controller will automatically perform the number of system purge cycles specified.

*Note*

*A System Purge draws contaminants out of the UUT. During this process, some of the contaminant can remain in the test hose. It is recommended to perform an additional Hose Purge after System Purge if such contamination is suspected.*

**Hose Purge**

Hose Purge is a function of the Controller that cleans test hoses before they are connected to a UUT. When pressure is vented after a test, liquids, oils, gases, or solvents from the UUT can adhere to the test hose and the coalescing filters. To help clear the contaminants from the test hose, the Controller has a hose purge function that forces the fluids out of the hose and into the CPS waste container.

Some contaminants are difficult to remove with air pressure alone and trace amounts can possibly stay in the test hose and CPS after the purge is complete. If contaminants remain after the purge, remove the hose, flush it with a solvent and then reattach and run the Hose Purge again.

When the Hose Purge starts, the Controller continuously flows gas for the length of the test (purge time) then vents to atmosphere.

**⚠ Caution**

**To prevent UUT cross-contamination, always use a like-colored test hose and CPS.**

Purge a test hose as follows:

1. Connect the male end of the test hose to the female **TEST** port on the Controller (see Figure 3-14).
2. Connect female end of the test hose to the male **HOSE PURGE** port on the Controller (see Figure 3-14).
3. Navigate to and select **Purge** on the bottom of the Main menu. The Purge menu opens.

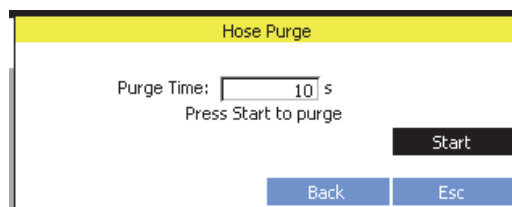

4. Key the purge time in seconds into the **Purge Time** field.
5. When ready, navigate to and select **Start** to start the test hose purge. When the purge is complete, the Controller beeps three times.
6. Disconnect the test hose from the **HOSE PURGE** port and put the protective cap on.

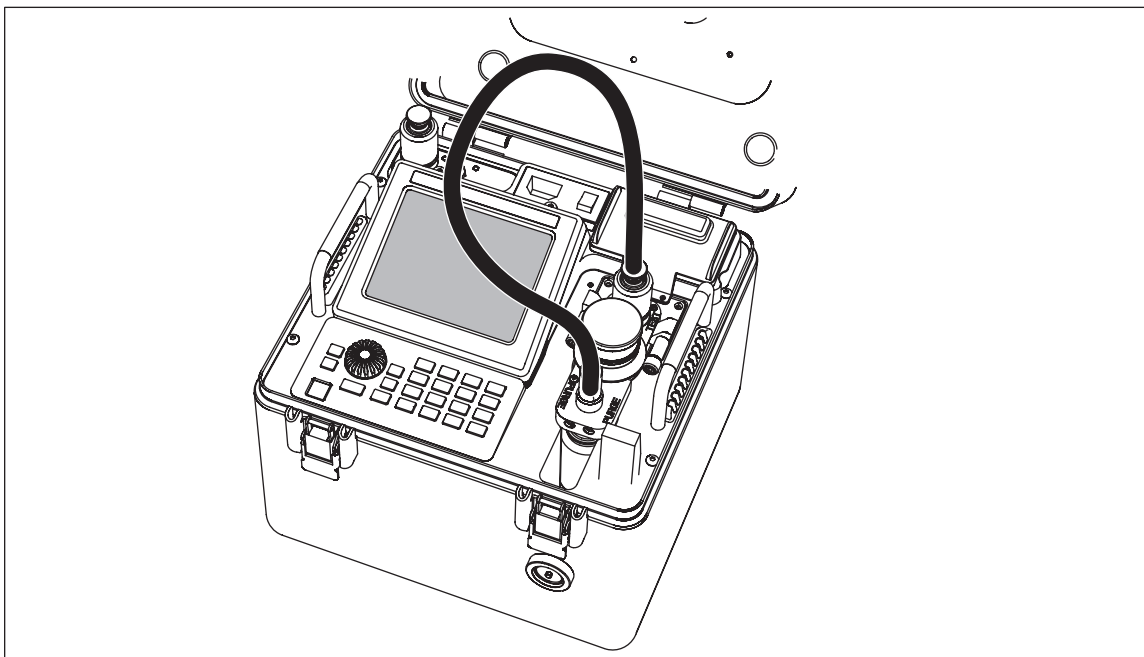

gxi028.eps

Figure 3-14. Hose Purge Configuration

### Leak Test

Leak Test is a function of the Controller that checks the Controller and UUT connection for pressure leaks. To detect leaks, the Controller generates pressure and monitors the rate of pressure change over a time period. The total change in pressure (dP) and average rate of change is shown on the Leak Test menu and stays on the menu until the test is reaccomplished. See Table 3-8 for a list of leak test parameters.

Test the system for leaks as follows:

1. Connect the male end of the test hose to the female **TEST** port on the Controller.
2. Connect female end of the test hose to the male **QC adapter** on the UUT.

#### Note

*A leak test can be done without a UUT connected to troubleshoot the Controller.*

3. Navigate to and select **Leak Test** on the bottom of the Main menu. The Leak Test menu opens.

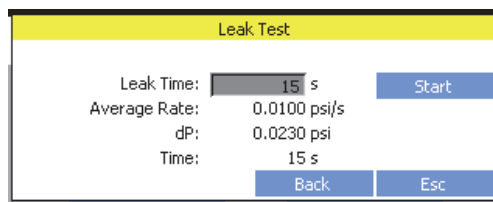

4. Key the leak test time in seconds into the **Leak Time** field.

#### Note

*The leak test menu contains an Average Rate, dP (pressure change), and Time values. These values are leak test result values and are not adjustable settings. When the menu opens, the values shown are from the last test completed and will update after the leak test is complete.*

5. Navigate to and select **Start** to start the leak test.
6. If the leak rates are excessive, search for a leak path around the adapter fittings first. To search for leaks, use a spray bottle with a mixture of water and diluted soap to spray on the fittings. If there is a leak, bubbles from the soap visually show where the leak is. See Figure 3-15.

**Table 3-8. Leak Test Parameters**

Parameter	Description
Leak Time	Amount of time to run the leak test.
Average Rate	Shows the average rate of change of pressure for the test completed. Measured in units for each second.
dP	Shows the total change in pressure for the test completed.
Time	Shows the length of time the test ran.

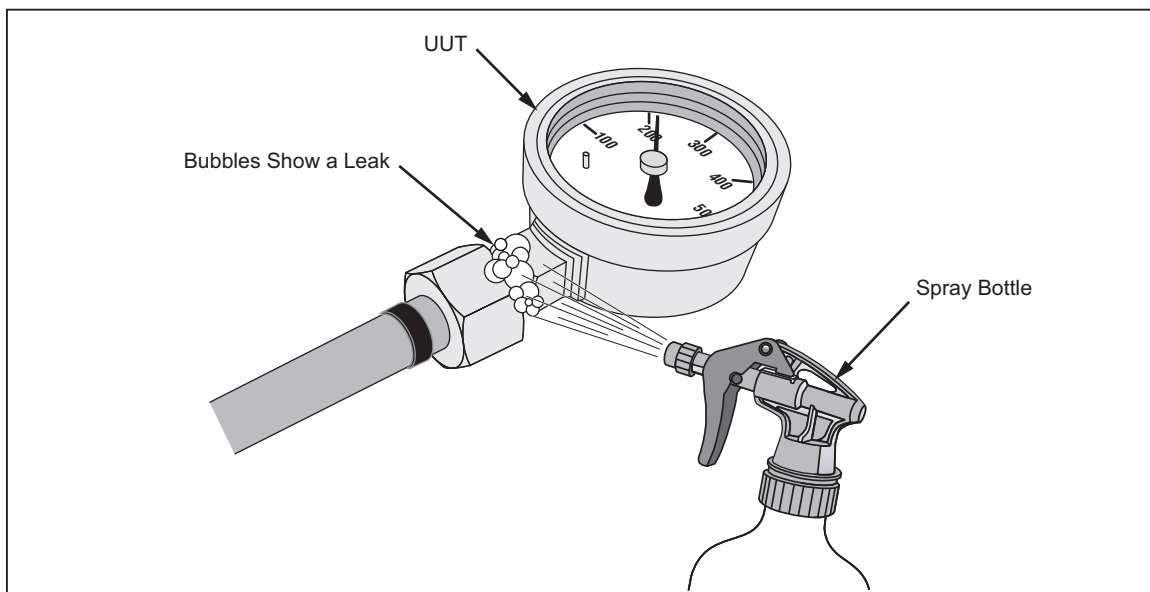

**Figure 3-15. Visual Leak Detection**

gxi045.eps

### Exercise

Exercise is a function of the Controller that pressurizes the UUT to a Max Target pressure then vents or otherwise sets pressure to the Min Target pressure. This sequence is repeated for the number of cycles set in the Exercise menu.

When the exercise starts, the Controller pressurizes the UUT to the Max Target pressure then depressurizes to the Min Target pressure. If Control at Target is set to “Yes”, the Controller uses the active pressure control mode to control the pressure for amount of time set in the Delay at Target. This is repeated for the number of cycles set.

Exercise a UUT as follows:

1. Connect the male end of the test hose to the female **TEST** port on the Controller.
2. Connect female end of the test hose to the male **QC adapter** on the UUT.
3. Turn-on the Controller (if necessary).

4. Navigate to and select **Exercise** on the bottom of the Main menu. An Exercise menu appears.

The screenshot shows a dialog box titled "Exercise" with a yellow header. It contains the following fields and values:

- Cycles: 10
- Max Target: 14.5400 psi
- Min Target: 0
- Control at Target: No
- Delay at Target: 0 s

At the bottom of the dialog are three buttons: "OK", "Back", and "Esc".

5. Configure the test as follows:
  - a. Set the number of times to exercise the UUT in the **Cycles** field.
  - b. Set the maximum target pressure in the **Max Target** field.
  - c. Set the minimum target pressure in the **Min Target** field.
  - d. Set the pressure control to **Yes** or **No** in the **Control at Target** field.

*Note*

*If “Yes” is selected for Control at Target, the Controller uses the active control mode set in the Controllers settings. Refer to “Pressure Control Modes” on page 3-8.*

- e. If Control at Target is set to “Yes”, set the time in seconds to keep the pressure at the target pressures in the **Delay at Target** field.
6. Select **OK** to save and close the menu to start the test.

**Table 3-9. Exercise Test Parameters**

Parameter	Description
Cycles	Set the cycles. A single cycle is one pressurization to the maximum target pressure and back to the minimum target pressure.
Max Target	Maximum target pressure.
Min Target	Minimum target pressure.
Control at Target	Set whether to control pressure at the target value. If Yes, then the test uses the active pressure control mode (see “Pressure Control Modes”). If no, then the Controller controls pressure to the maximum target value then immediately controls pressure to the minimum target value.
Delay at Target	Amount of time to control pressure if Control at Target is set to “Yes”.

## Test a UUT

Use the instructions in the subsequent sections to set up and run a test on a UUT.

### The Test Menu

The Test menu allows for quick access to run a test, edit a test, or make a new test (see Table 3-10). Each UUT type selection has different test options and settings that show on the menu. Once a UUT type is selected, the test drop-down menu shows a list of all saved tests for the UUT type and shows the related test options and settings on the test menu. If a test cannot be located in the list with the necessary test parameters, a new test can be made.

*Note*

*The New Test menu contains a “Matching Test” field. This field compares the test being made to the tests saved to memory. If a test is found that matches the parameters of the test being made, the matching test shows in the Matching Test field. This helps prevent the creation of multiple tests with the same settings.*

See “Test Sequences” on page 3-26 for information on how to manage and use test files.  
See “Run a Test Sequence” on page 3-33 for instructions on how to run a Test Sequence.

**Table 3-10. Test Menu**

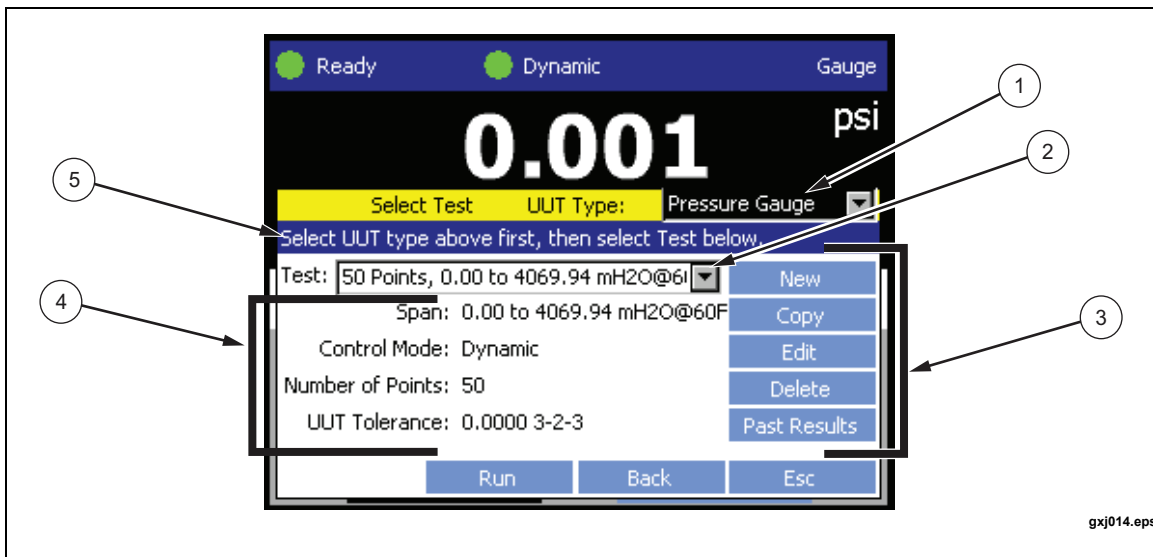

Item	Name	Function
①	UUT Type	Shows the selected UUT type and opens a menu to change the UUT type. The UUT types are: Pressure Gauge, Compound Gage, Pressure Switch, and Transducer.
②	Test	Test selection list. List is populated with saved tests and each UUT type has a different list. Each test has a naming convention to easily see the parameters of the test in the test name (see “About Test Sequences” on page 3-28).
③	Test Management Buttons	Buttons used to make, edit, and manage tests. See “Test Sequence Actions” on page 3-28 for test file management instructions.
④	Test Settings	Shows the test settings for the selected test.
⑤	On-Screen Instructions	Shows on-screen instructions and information. The on-screen instructions has two settings: Standard and Reduced. See the Preferences tab in the “The Settings Menu” in Chapter 2.

## Test Sequences

A Test Sequence is a test file that is configured by the user and saved to Controller memory. These test files can be created, edited, saved, and deleted. Each test file contains test settings and parameters that the Controller uses when the test is run. After the test is run, the user uses the on-screen prompts to complete the test. After the test is complete, the user can print or see a test report (see “View Test Results” on page 3-37).

Each test has a specific naming convention so that the main parameters of the test can be seen in the filename. Once the test is selected, the other parameters of the test are shown on the test menu. The test naming conventions are illustrated in Figure 3-16.

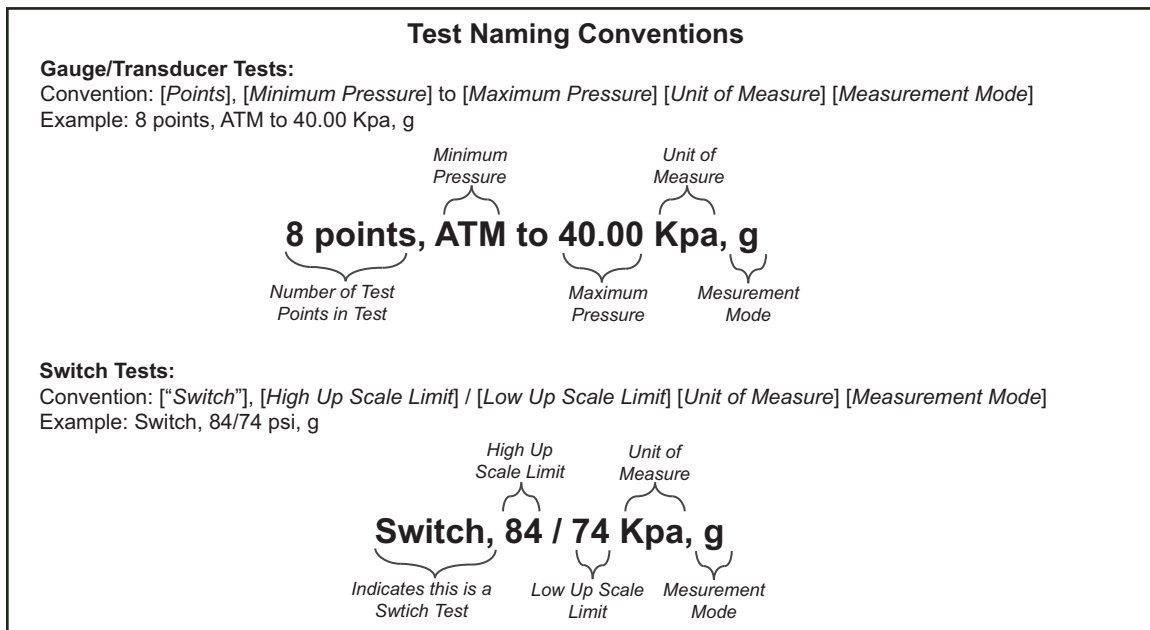

Figure 3-16. Test Name Convention

## Test Sequence Actions

Use the Test menu to:

- Create a new test (see “Make a New Gauge or Transducer Test” on page 3-30 or “Make a New Pressure Switch Test” on page 3-33).
- Copy a saved test (see “Copy a Test” on page 3-29).
- Edit a saved test (see “Edit a Saved Test” on page 3-29).
- Delete a saved test (see “Delete a Saved Test” on page 3-29).

The Controller can save 250 tests to internal memory. Tests are classified by the UUT type: Pressure Gauge, Compound Gauge, Transducer, and Switch.

### Note

*The Gauge/Transducer New Test menu looks different and contains different test settings than the Pressure Switch New Test menu.*

As part of the standard factory settings, the Controller comes with a basic set of common tests for each UUT Type. These tests can be edited to fit the calibration requirements (see “Edit a Test” on page 3-29).

### Note

*The Maintenance function “Reset to Defaults” erases all the tests.*



### Find a Saved Test

To find and load a saved test:

1. From the Main menu, select **Test** to open the test menu.
2. Choose **Pressure Gauge, Compound Gauge, Pressure Switch, or Transducer** from the UUT Type drop-down box.
3. Select the **Test** drop-down box on the test menu to view the saved tests. Select a test to see the parameters of the test on the test menu.

#### Note

*The tests name contains primary test information to help locate tests (see Figure 3-16).*

4. Run the Test Sequence (see “Run a Test Sequence” on page 3-33 for instructions on how to run the test).

### Edit a Test

To edit a saved test:

1. Find the test to edit (see “Find a Saved Test” in this section).
2. Select **Edit** to open the test Edit menu.
3. Edit the test as necessary. Push **OK** cycle through the menus and to save.
4. Run the Test Sequence (see “Run a Test Sequence” on page 3-33 for instructions on how to run the test).

### Copy a Test

To copy a test:

1. Find the test to copy (see “Find a Saved Test” in this section).
2. Select **Copy** to open the test Edit menu.
3. Edit the test as necessary. Push **OK** cycle through the menus and to save.
4. Run the Test Sequence (see “Run a Test sequence” on page 3-33 for instructions on how to run the test).

### Delete a Test

To delete a test:

1. Find the test to delete (see “Find a Saved Test” in this section).
2. Select **Delete**.
3. Select **OK** to confirm deletion.

### Make a New Gauge/Transducer Test

Create a new pressure gauge, compound gauge, or transducer test as follows:

#### Note

The Gauge/Transducer New Test menu looks different and contains different Test Settings than the Pressure Switch new test menu. Figure 3-17 shows the two menus.

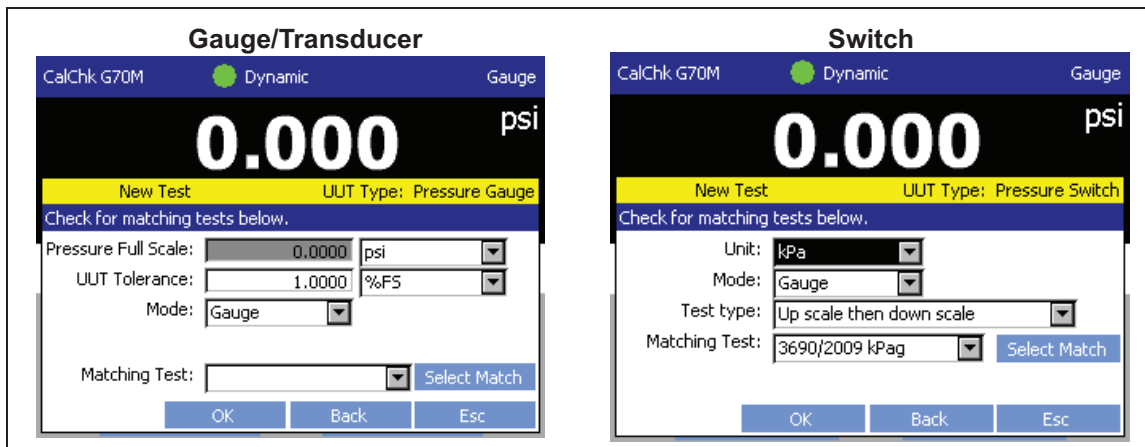

Figure 3-17. Gauge/Transducer and Switch New Test Menus

gxi041.eps

1. From the Main menu, select **Test** to open the run test menu.

#### Note

When **New** is selected, the Controller uses the parameters contained in the test file shown in the Test drop-down box to populate the initial values of the new test. To make a new test quickly, select a similar test in the Test drop-down box before **New** is selected.

2. Select **Pressure Gauge**, **Compound Gauge**, or **Transducer** from the UUT Type drop-down box.
3. Select **New** on the test menu to open the New Test menu.

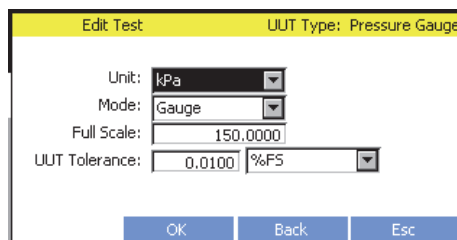

4. Configure the test as follows:

#### Note

As a new test is being made and parameters are selected, the Controller actively searches the saved test files for tests that have the same test parameters. If the Controller finds a match, the Controller shows the test matches in the Matching Test field. The Controller searches and updates the Matching Test Field each time a field is changed. If the Matching Test Field is selected and then **Select Match** is selected, the new test is not saved and the Controller opens the test menu with the matching test loaded.

- a. Select a pressure unit from the **Unit** drop-down box.
  - b. Select a measurement mode from the **Mode** drop-down box.
  - c. Key in the full scale limit of the UUT in the **Full Scale** field.
  - d. Key in the tolerance of the UUT in the **UUT Tolerance** field and select the unit of scale from the drop-down box.
  - e. Push **OK** to open the edit test menu.
5. Use the Edit Test menu to set up the test points as follows (refer to Table 3-11):
- a. Manually change the target values, or use auto fill to automatically set the test points as follows:
    - To manually set the test points, use **Add** and **Delete**. To change the target value of the test point, select the test point in the sequence window and key the value into the **Test Point** field.
    - To automatically make a complete series of test points, select **Auto Fill** to open the auto fill menu. Set the maximum target pressure, the minimum target pressure, the step percentage, and the test direction and select **OK**. The Controller automatically divides the maximum pressure by the step number to create the number of test points (see Table 3-11 for information on each field). After the test points are made, they can be manually adjusted on the Edit Test menu.
  - b. Add vent to atmosphere (ATM) test points as required. To add an ATM test point, select a test point in the sequence window and then select **Add ATM**. The point is added below the selected test point.

**Table 3-11. Edit Test Menu**

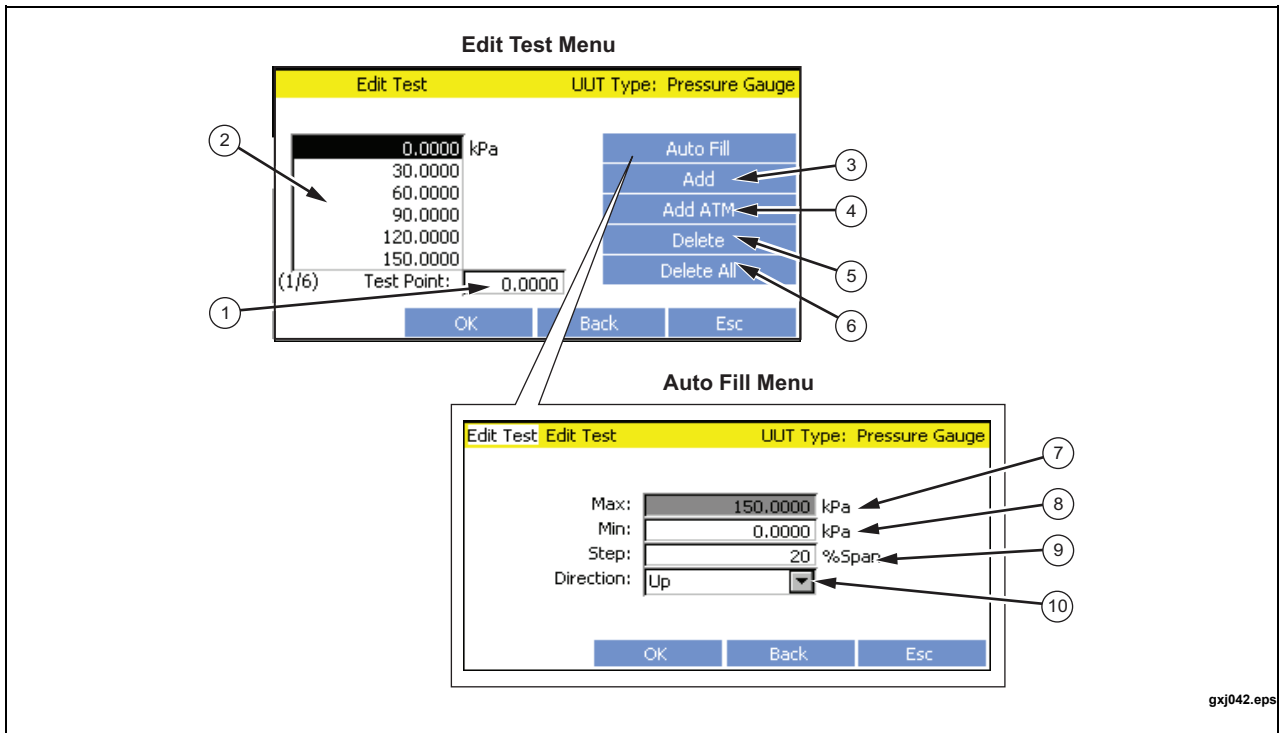

gxj042.eps

Item	Name/Button	Function
①	Test Point Target Value	Use to change the target value of the test point.

Table 3-11. Edit Test Menu (cont.)

Item	Name/Button	Function
②	Sequence Window	Shows the number and target value of each test point.
③	<b>Add</b>	Add a test point to the test.
④	<b>Add ATM</b>	Add a vent to atmosphere test point. An ATM test point vents all pressure to atmosphere to allow the user to make a vented atmosphere measurement.  <i>Note</i>  <i>ATM is used only in the Absolute Measurement mode.</i>
⑤	<b>Delete</b>	Delete a selected test point from the test.
⑥	<b>Delete All</b>	Delete all test points from the test.
⑦	Max	Maximum target pressure of the test. Value is limited to the tolerance of the UUT set in the new test menu.
⑧	Min	Minimum target pressure of the test. Value is limited to the tolerance of the UUT set in the new test menu.
⑨	Step	Divisor percentage that sets the number of test points in a test. The Controller divides the maximum target value by the span percentage to give the number of test points and target value for each test point. For example, if the maximum target value is set to 150 psi and the step is set to 20 %, then the Controller makes six test points in 30 psi increments.
⑩	Direction	Direction of the test. The four choices are:  <b>Up</b> – Make a set of test points with the first test point at the minimum target value and the last test point at the maximum target value.  <b>Down</b> – Make a set of test points with the first test point at the maximum target value and the last test point at the minimum target value.  <b>Up/Down</b> – Make a set of test points with the first test point at the minimum target value, the test steps up to the maximum target value then back down to the minimum target value.  <b>Down/Up</b> – Make a set of test points with the first test point at the maximum target value, the test steps down to the minimum target value then back up to the maximum target value.

- c. Push **OK** to go to the next page of the edit test menu.

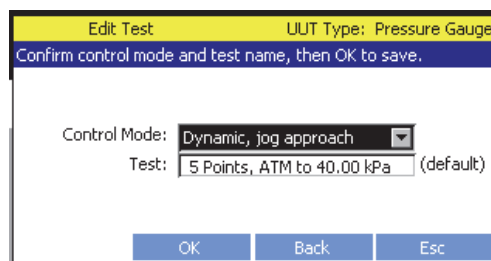

6. Set the control mode to use for the test (see “Pressure Control Modes” on page 3-8).

*Note*

*Each test has a control mode setting. When the test is run, the Controller uses the Pressure Control mode in the test and overrides the Pressure Control mode set in the general Controller settings. After the test is complete, the Controller changes back to the Control Mode set in the general Controller settings.*

7. Change the test name (if required).
8. Push **OK** to save the test and exit to the Main test menu. The new test is loaded and is now shown on the Main test menu.
9. Run the Test Sequence (see “Run a Test Sequence” on page 3-33 for instructions on how to run the test).

### Make a New Pressure Switch Test

Create a new pressure switch test as follows:

*Note*

*The Gauge/Transducer New Test menu looks different and contains different test settings than the Pressure Switch New Test menu. Figure 3-17 shows the two menus.*

1. From the Main menu, select **Test** to open the run test menu.

*Note*

*When **New** is selected, the Controller uses the parameters contained in the test file shown in the Test drop-down box to populate the initial values of the new test. To make a new test quickly, select a similar test in the Test drop-down box before **New** is selected.*

2. Select **Pressure Switch** from the UUT Type drop-down box.
3. Select **New** on the test menu to open the New Test menu.
4. Configure the test as follows:

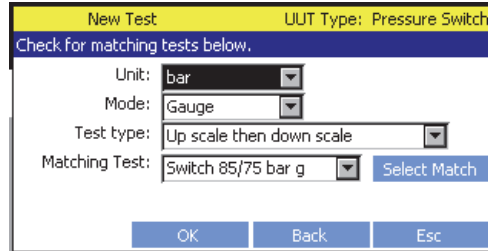

*Note*

*As a new test is being made and parameters are selected, the Controller actively searches the saved test files for tests that have the same test parameters. If the Controller finds a match, the Controller shows the test matches in the Matching Test field. The Controller searches and updates the Matching Test Field each time a field is changed. If the Matching Test Field is selected and then **Select Match** is selected, the new test is not saved and the Controller opens the test menu with the matching test loaded.*

- f. Select a pressure unit from the **Unit** drop-down box.
  - g. Select a measurement mode from the **Mode** drop-down box.
  - h. Select a test direction from the **Test Type** field.
  - i. Push **OK** to continue.
5. Configure the test limits as follows:

New Test UUT Type: Pressure Switch  
Check for matching tests below.  
High up scale limit: 105.0000  
Low up scale limit: 95.0000  
High down scale limit: 85.0000  
Low down scale limit: 75.0000  
Matching Test: Switch 85/75 bar g Select Match  
OK Back Esc

- a. Select and key in the **High up scale limit** pressure value.
  - b. Select and key in the **Low up scale limit** pressure value.
  - c. Select and key in the **High down scale limit** pressure value.
  - d. Select and key in the **Low down scale limit** pressure value.
  - e. Push **OK** to continue.
6. Set the Switch Read to **Manual** or **Automatic**.

*Note*

*Pressure switches are electro-mechanical devices that change their output state (on or off) at a prescribed pressure value. These states are usually associated with the opening and closing of an electrical circuit as a result of the change in pressure. The open or closed state of the electrical circuit can be read with a continuity checker. The Handheld Control has a built in continuity check function that communicates with the Controller. If Switch Read is set to Automatic, the Handheld automatically measures the pressure that the pressure switch changed its state. If the Switch Read is set to Manual, the user pushes **MEASURE SELECT** to manually measure the pressure that the pressure switch changed its state.*

Edit Test UUT Type: Pressure Switch  
Switch Read: Manual  
Test: Switch 105/75 bar (default)  
OK Back Esc

7. Change the test name (if required).

## Run a Test Sequence

A Test Sequence lets the user fully configure and run a test to calibrate a UUT. After a Test Sequence is complete, the results can be printed to a test report. See “Test Files” for instructions on how to make a new test, edit a saved test, and manage saved tests.

### Note

*Before a Test Sequence is run, the user must decide whether to use the Handheld Control or the control panel on the Controller.*

To run a Test Sequence:

1. Connect the Controller to Intensifier or the Nitrogen Cylinder supply and set up the supply (see “Set the Internal and External Supply Setting” in Chapter 2).
2. Prepare and connect to a UUT (see “Connect to a Unit Under Test (UUT)” in Chapter 2).
3. Turn on the Intensifier and select a boost pressure, if required (see “Set Boost Pressure” in Chapter 4).

### Note

*Boost pressure selection is dependent on the pressure necessary to complete the UUT calibration. For a typical UUT calibration, select a boost pressure equal to or greater than the maximum pressure necessary to complete the UUT calibration. For multiple UUT calibrations in the same location, set the boost pressure to the lowest available selection that is higher than the highest pressure necessary to complete the UUT calibrations. The higher the target supply selection, the faster the Nitrogen Supply discharges.*

4. Select **Test** on the Main menu to open the Run Test menu.
5. Select a UUT type from the **UUT Type drop-down** box.
6. Select a test from the Test drop-down box (see “Test Sequences” on page 3-26).
7. Select **Run** to continue.
8. Follow the on-screen instructions to set the Internal or External supply setting (see Chapter 2 for more information on the Internal and External supply selections). Select **OK** to continue.
9. Select pre-test function to be performed (Hose Purge, System Purge, Leak Test, or Exercise a gauge). Once finished, select **Run Local** or **Run Handheld** to continue.

### Note

*The hose purge, leak test, or exercise can be run from this menu. If a tool is run, make sure to select **Back** to return to the test menu. If **Esc** is selected, the Test menu closes.*

10. Run the test as follows:

- a. On the run test menu, select **Start** to run the test when ready. The Controller controls pressure to the first target pressure test point and controls the pressure with the set control mode set in the test settings.
- b. Push **MEASURE SELECT** to make a measurement when the measurement indicator shows **Ready**.
- c. Select Advance. The Controller controls pressure to the next target pressure test point.

*Note*

*Use **Previous Point** to redo a test point.*

- d. Push **MEASURE SELECT** to make a measurement when the measurement indicator shows **Ready**.
  - e. Repeat steps c and d again for the remaining test points.
  - f. After all test points are complete, the results will be automatically displayed.
11. Fill in the UUT information on the UUT information menu then select **OK** to open up the run test menu.

*Note*

*The information on this menu is used to populate the calibration report.*

12. Select **Finish** to close and save the test results or **Print** to print the test results.

*Note*

*To print the test results, connect and turn on the printer. If a printer is not available at the conclusion of the test, the test results can be viewed at a later time and printed from the "Select Test" menu. To see previous test results, select the test from the Test drop-down menu and select "Past Results".*



## View Test Results

After a test is complete, the test results can be viewed on the Test Results menu. The Test Results menu shows each test point, target pressure, deviation pressure, deviation percentage, and whether the UUT passed or failed the test point.

To determine the pass or fail criteria, the Controller compares the reference value (the Controller) to the UUT value (UUT reading). If the difference between these two values is greater than the UUT tolerance that was set when the test was configured, the Controller shows “Fail” for that test point.

**Table 3-12. Test Results Menu**

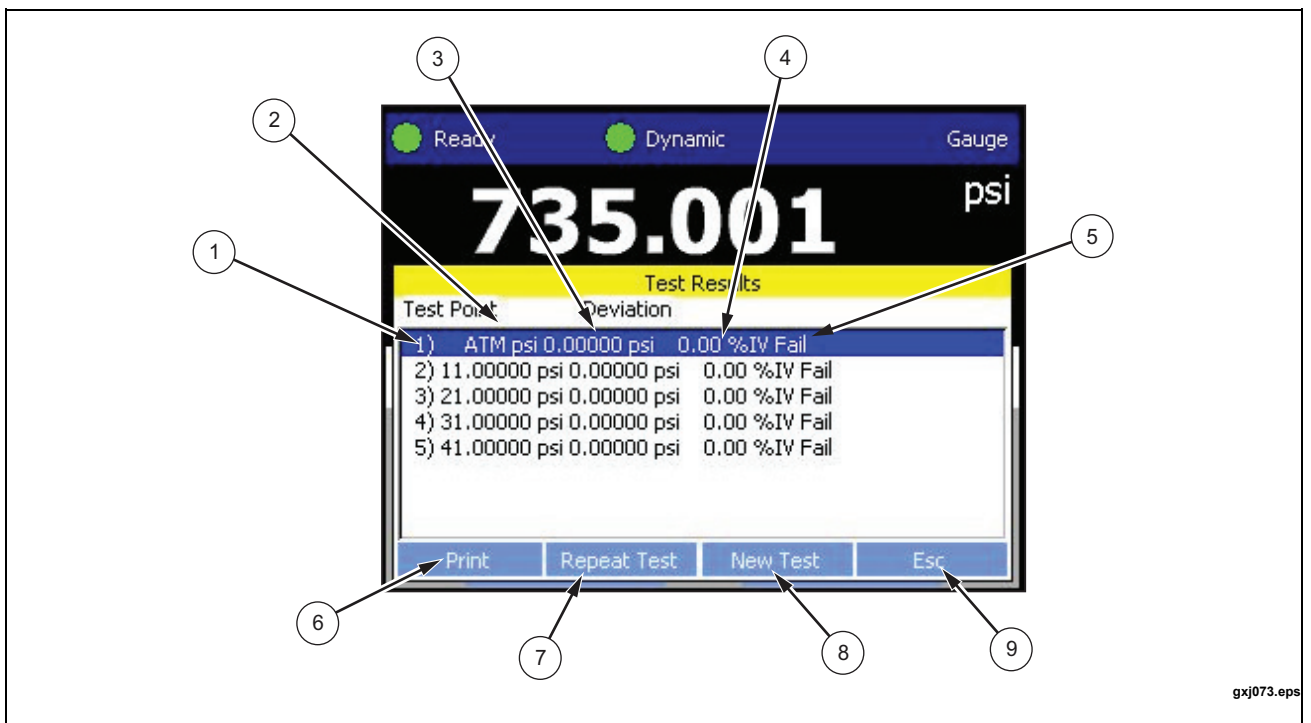

gxj073.eps

Item	Name/Button	Function
①	Test Point	Test point number.
②	Target Pressure	The target pressure of the test point.
③	Deviation	The amount of deviation between the reference value and the UUT value.
④	Percent of Deviation	Deviation in percentage format.
⑤	Pass or Fail Indicator	Shows “Fail” if the amount of deviation is more than the UUT tolerance and shows “Pass” if within the UUT tolerance.
⑥	Print	Print the results on a formal test report (see “Print Report” on page 3-38).
⑦	Repeat Test	Repeat the test on the UUT. The results will have a new timestamp.
⑧	New Test	Opens the Run Test menu to run a new test.
⑨	Esc	Cancel and return to the Main menu.

View Past Results as follows:

1. Select **Test** on the Main menu to open the Run Test menu.
2. Select a UUT type from the **UUT Type drop-down** box.
3. Select a test from the Test drop-down box (see “Find a Saved Test” on page 3-29).
4. Select **Past Results** to open the Find Results menu.

*Note*

**Past Results** is hidden if there are no results stored for the selected test.

5. Use **<<** and **>>** to cycle through the results then select **Select** to open the Test Results menu.

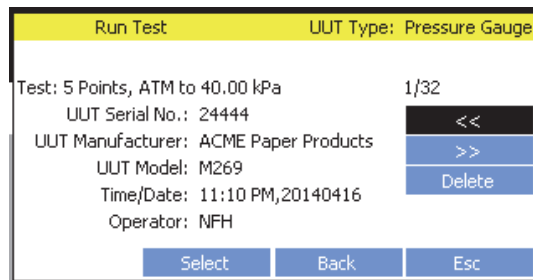

6. View the test results on the menu or print a report (see “Print a Test Report”).

## Print a Test Report

From the Test Results menu, a Test Report can be printed that contains the UUT information and also the test results.

To connect a printer and print a report:

1. Connect the printer to the Printer port on the Controller.

*Note*

*The printer must natively support the PCL5 standard. Printers that emulate the PCL5 standard may not function properly. Printers that require a driver to support PCL5 (“Host based printing”) will not work. Consult your printer manufacture for the details about your printer.*

2. Select **Settings** on the Main menu then select the Remote tab.
3. Select **Print Test Page**. The Controller sends a test page to the printer. If the printer prints the test page, print the test report. See “View Test Reports” to find the test results to print. If the printer does not print a test page:
  - a. Check the connections.
  - b. Check to make sure the printer is on, ready, and has paper loaded.
  - c. Check the printer for error messages and retry.

# **Chapter 4**

## ***Intensifier Operation***

<b>Title</b>	<b>Page</b>
Introduction.....	4-3
Turn On the Intensifier .....	4-3
Choose a Boost Pressure.....	4-3
Set Boost Pressure .....	4-4
Vent the System.....	4-5
Isolate Pressure .....	4-5



## Introduction

This chapter supplies boost pressure information and instructions on how to set the boost pressure on the Intensifier.

## Turn On the Intensifier

To turn on the Intensifier, connect the mains power cord and toggle the power switch to the (I) position. The internal electronics will perform a self-check. If any problems are encountered, the LEDs on the front panel will indicate what error is present. See Chapter 6 for troubleshooting information.

## Choose a Boost Pressure

The Pressure Intensifier (the Intensifier) is an electric pressure booster system that can boost gas pressure supply from (500 to 3,000) psig up to 10,000 psig. The Intensifier has a pressure selection control panel, a pressure gauge, vent and isolation pressure valves, and QC supply and outlet ports.

### Note

*To drive the Intensifier, >500 psi nitrogen supply is necessary (not to exceed 2,000 psi). Operation of the Intensifier with <500 psi is not recommended as performance of the Intensifier will be degraded and could cause extra wear on the system.*

When a boost pressure is selected, an electronically controlled servo motor drives a four piston, mechanical boost pump. The rate of pressure accumulation is dependent on the supply pressure, and the motor speed and test volume. The higher the supply pressure, the faster the pressure generates. Pressure generated by the boost pump is stored in a 15 cc internal accumulator and in the system pressure lines.

An electrical pressure sensor monitors and measures the pressure in the accumulator and transmits pressure measurement values to the electronic motor controller. As the measured pressure in the accumulator approaches the selected pressure value, the motor controller decreases the rate of pressure generation. The speed of the motor changes as necessary to hold the selected pressure in the system (referred to as “Pressure on Demand”).

### Note

*The Intensifier is not made to store pressure when not in operation. After **STOP** is pushed, pressure slowly bleeds from the accumulator.*

The Intensifier continuously supplies the pressure selected until **STOP** is pushed. This makes sure that the Controller has sufficient pressure available to complete the UUT calibration.

Boost pressure selection is dependent on the pressure necessary to complete the UUT calibration. For a typical UUT calibration, select an intensifier pressure equal to or greater than the maximum pressure necessary to complete the calibration.

*Note*

*The Intensifier boost pressure is typically 5% to 8 % higher than the set pressure requested. This feature allows the set pressure to be equal to the maximum pressure required for calibration.*

For multiple UUT calibrations in the same location, set the boost pressure to the lowest available selection that is higher than the highest pressure necessary to complete the UUT calibrations.

*Note*

*The higher the target supply selection, the faster the Nitrogen Supply depletes.*

## Set Boost Pressure

Set a boost pressure as follows:

1. Connect the Intensifier to the Nitrogen Cylinder and the Controller. See “Configure the Pressure Supply” in Chapter 2.
2. Turn on the Intensifier.
3. Close the Vent Valve and fully open the Isolation Valve.
4. Use the Target Boost Pressure selection keys to select a boost pressure. After a boost pressure is selected, the green LED to the right of the key illuminates and stays illuminated until **STOP** is pushed. If the LED next to the key does not illuminate after a boost pressure selection, refer to “Pressure Selection and LED Indications” in Chapter 6.

*Notes*

- *The Intensifier is a pressure on demand system and automatically generates pressure as necessary to keep the pressure at the selected boost pressure.*
  - *Intensifier pressure selection is dependent on the pressure necessary to complete the UUT calibration. For a typical UUT calibration, select a boost pressure equal to or slightly greater than the maximum pressure necessary to complete the UUT calibration. The Intensifier will generate a pressure slightly higher than the selected intensifier pressure. This reduces the risk of a UUT overpressure and prolongs pump life by optimizing pump speed to the required pressure range.*
  - *For multiple UUT calibrations in the same location, set the boost pressure to the lowest available selection that is higher than the highest pressure necessary to complete the UUT calibrations. The higher the target supply selection, the faster the Nitrogen Supply discharges.*
5. When finished, push **STOP** or turn off the Intensifier to stop pressure generation.
  6. Open the Vent Valve to vent the pressure from the Intensifier and the QC fittings.

## Vent the System

Vent the Intensifier as follows:

1. Push **STOP** to turn off pressure generation.
2. Turn off the Nitrogen Cylinder Regulator.
3. Turn the Vent Valve counterclockwise to vent the pressure.

### **⚠ Caution**

**To prevent damage to the knob, do not force the knob after it reaches the full open or closed position.**

### *Note*

*Pressure from the entire system will be vented if the Vent Valve is opened when the Isolation valve is open. If the Isolation Valve is closed when the Vent Valve is opened, only the pressure at the outlet port will be vented.*

4. After vented, turn the Vent Valve clockwise to close the valve.

## Isolate Pressure

The Isolation valve lets the operator isolate the Intensifier pressure from the rest of the system. When the Isolation Valve is closed and the Vent valve is open, the pressure is released and the QC fitting can be removed from the Outlet Port.

Isolate pressure in the Intensifier as follows:

1. Turn the Isolation Valve clockwise to close the valve.

### **⚠ Caution**

**To prevent damage to the valve, do not force the knob after it reaches the full open or closed position.**

2. Slowly turn the Vent Valve counterclockwise to vent the pressure out of the system between, but keep the Intensifier pressurized.
3. After vented, turn the Vent Valve clockwise to close the valve and turn the Isolation Valve counterclockwise to resume normal operation.





# Chapter 5

## Remote Operation

Title	Page
Introduction.....	5-3
USB Remote Interface Setup.....	5-4
IEEE-488 (GPIB 488.2) Remote Interface Setup.....	5-4
Remote Operation Commands.....	5-4
Limitations of Using Remote Commands .....	5-4
Overview of Command Structures .....	5-5
Alphabetical List of Remote Commands.....	5-6
Remote Command Format .....	5-8
Common and Status Commands.....	5-9
Specific Commands.....	5-10
488.2 Status System.....	5-19
Status Byte Register .....	5-20
Standard Event Register .....	5-22
Ready Status Register.....	5-22
Operation Status Register.....	5-23
Remote Errors .....	5-23



## Introduction

Remote operation of the Controller from a computer is done with commands through the serial USB interface or the GPIB 488.2 interface.

*Note*

*The RS-232 port cannot be used for remote operation.*

The PC communicates with the Controller with serial commands in SCPI (Standard Commands and Programmable Instruments) format. These commands let the user set pressure targets, change control setting and retrieve pressure measurements.

When the USB port is connected to a PC, a USB cable is connected to an available USB slot which shows on the PC as a virtual com port (VCP). The GPIB port can be connected to a PC that has a special GPIB 488.2 controller interface and appropriate host software to send SCPI commands and receive queries replied from the Controller. When the GPIB connection is established, it is important to give the Controller a custom GPIB address (1 to 31) to be used to identify it from other possible devices connected to the PC. The default GPIB address for the 4322 is “10”. The IEEE-488 port can also be used to communicate with an external pressure reference for the self-calibration function.

*Note*

*The RS-232 port cannot be used for remote operation.*

**Table 5-1. Power and Remote Interface Panel**

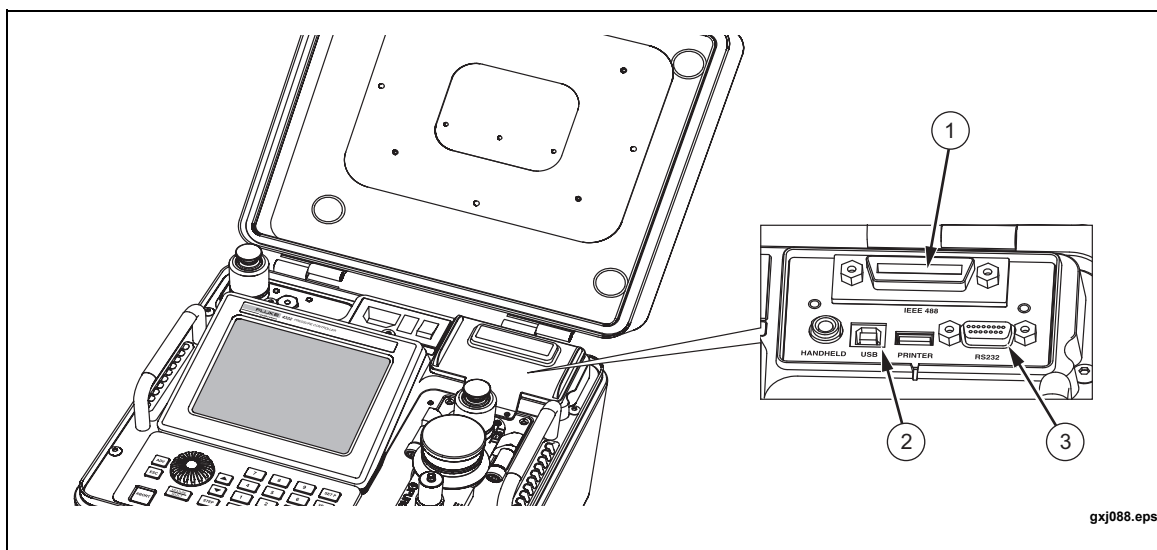

Item	Name	Function
①	IEEE-488	IEEE-488.2 GPIB remote operation interface.
②	USB	USB 2.0 remote operation interface.
③	RS-232	Updating firmware.

Use the instructions in the subsequent sections to set up a USB or GPIB remote interface connection.

### **USB Remote Interface Setup**

The USB interface emulates a virtual com-port (VCP) on a Windows XP (SP3 or later), Windows Vista or Windows 7 based computer.

To use the USB interface for remote operation, a driver needs to be installed on the computer. The driver is included in Windows but you must use the identification file on the CD that came with the 4322 to enable the Windows driver. If the CD becomes lost, go to the Fluke website at [www.flukecal.com](http://www.flukecal.com) to download the INF file and related instructions to install the file.

The USB VCP communicates at 115200 baud, 8 bit word length, no parity, 1 stop bit (“115200,8,N,1”). These settings are fixed and cannot be changed on the Controller. Any application that needs to remotely communicate with the Controller must be set to communicate to the port that Windows appoints to the USB VCP.

### **IEEE-488 (GPIB 488.2) Remote Interface Setup**

Use the instructions in this section to connect and configure an IEEE-488 remote interface. This type of interface is also commonly referred to as a GPIB or GPIB 488.2 interface.

An appropriate GPIB 488.2 cable (supplied) must be used to connect the Controller to a host computer or a supported reference if used for the self-calibration function. The host computer must have an appropriate GPIB 488.2 host interface adapter to connect to.

The GPIB PC adapter should come with the appropriate drivers and communication libraries to set up communication. Please see the user documentation for the GPIB PC adapter for installation and operation instructions.

The 4322 IEEE-488 interface must be set to an address that is unique from any other devices also connected to the same computer. This can be set within the Controller Settings menu. The default address is ‘10’.

## **Remote Operation Commands**

### **Limitations of Using Remote Commands**

The Calibrator only accepts remote commands when it is not being used via the front panel or if the front panel interface is within a sub-menu. Otherwise the Calibrator will send an error into the error queue and will not execute the command.

## Overview of Command Structures

The Calibrator accepts commands for setting parameters, executing functions or responding with requested data. These commands are in the form of strings of ASCII-encoded characters. The 4322 command syntax conforms to the syntax and style of the SCPI-1994 standard.

Commands consist of a command header and, if necessary, parameter data. All commands must be terminated with either a carriage return (ASCII 0D hex or 13 decimal) or new line character (ASCII 0A hex or 10 decimal). Responses are terminated with both a CR and a LF.

Command headers consist of one or more mnemonics separated by colons (:). Mnemonics may use letter characters, the underscore character (`_`), and possibly numeric digits as well. Commands are not case sensitive. Mnemonics often have alternate forms. Most mnemonics have a long form that is more readable and a short form consisting of three or four characters that is more efficient.

A mnemonic can end with a numeric suffix that specifies one of a set of independent function blocks such a sensor index. If a numeric suffix is omitted when a particular block must be specified, an error is generated (“Header suffix out of range”).

Query commands are commands that request data in response. Query commands have a question mark (?) immediately following the command header. The query operator can also be used when arguments are present if a response is desired. If a query operator is used and there is an error with the command, the reply will indicate the error. Responses to query commands are generated immediately and placed in the output buffer. Responses are then transmitted automatically to the PC. When using the USB interface, responses are lost if not read before the next command is received.

When using the GPIB interface, responses will be queued up and held until they are read back on the host computer. Improper responses to the host computer can occur if the queue becomes full. Use the `SYST:ERR?` query to check for errors or that the incoming command queue has not overflowed.

### *Note*

*Use of the query form with every command and always waiting for a response prevents queue overflows and improper responses. As an example, use `*ESR? 2` and wait for a response instead of `*ESR 2`. The `*CLS` command can be used to clear the queue to ensure there are no past responses.*

Some commands require parameter data to specify values for one or more parameters. The command header is separated from the parameter data by a space (ASCII 20 hex or 32 decimal). Multiple parameters are separated by a comma(,).

The Calibrator does allow compound commands (multiple commands per line separated with semicolons) but care must be taken as some commands can start a process which can take time to execute and the execution subsequent commands can interfere with previous commands.

Remote commands are not executed when the Controller is busy with local operations (such as running a calibration). If a command is sent when the Controller is busy, the command is ignored and an error is placed in the error queue. Otherwise, basic communication with the Controller puts the system into remote mode, and aborts any locally executed functions. This also locks the front-panel controls and the Handheld until placed back into local mode using the ESC key or a GPIB "go to local" request.

### Alphabetical List of Remote Commands

Table 5-2 lists the remote commands in alphabetical order.

**Table 5-2. List of Alphabetical Commands**

Command	Quick Description
*CLS	Clears the error and communication buffers.
*ESE[?]	Read or set the Standard Event Status Enable Register.
*ESR?	Read the Standard Event Status Register.
*IDN?	Read the identification information.
*OPT?	Read the optional hardware that is installed.
*RST	Reset the 4322 to a known state.
*SRE[?]	Read or set the Service Request Enable Register.
*STB?	Read the Status Byte Register.
CALx:PRES:DATA[?] [data,,]	Read or set the user calibration coefficients.
CALx:PRES:DATE[?] [yyyy,mm,dd]	Read or set the user calibration date.
CALx:PRES:SER?	Read the sensor's serial number.
CALC:LIM:LOW[?] [limit]	Read or set the upper limit
CALC:LIM:UPP[?] [limit]	Read or set the lower limit
INP:TYPE[?] [type]	Read or set the supply input type.
MEAS[x]:PRES?	Reads the pressure for the sensor.
MEAS[x]:PRES:ALL?	Reads all 3 elements of the sensor.
MEAS[x]:PRES:SLEW?	Reads the slew rate.
MEAS[x]:ZERO:VAL[?] [PZ,A,PZ,B,PZ,C]	Read or set the zero values.
MEAS:ZERO:STAT[?] [0 1]	Read or set the autozero state.

**Table 5-2, List of Alphabetical Commands (cont.)**

Command	Quick Description
OUTP:STAT[?] [0 1]	Read or set the current controller state.
OUTP:MODE[?] [mode]	Read or set the current controller operating mode.
SENS:PRES:RES[?] [res]	Read or set the pressure resolution
SENS:PRES:MODE[?] [mode]	Read or set the pressure measurement mode.
SENS:PRES:RANGE? [range]	Read or set the range of the active sensor.
SENS:PRES:REF:HEIG[?] [head]	Read or set the head height.
SENS:PRES:REF:MED[?] [gas]	Read or set the gas medium.
SOUR:PRES:CONT[?] [hold]	Read or set the 4322 control dead-band.
SOUR:PRES:LEV:IMM:AMPL[?] [targ]	Read or set the set-point.
SOUR:PRES:LEV:IMM:AMPL:AUTO[?] [targ]	Read or set the set-point.
SOUR:PRES:LEV:IMM:AMPL:VENT[?] [0 1]	Read or set the vent status.
SOUR:PRES:MODE[?] [mode]	Read or set the 4322 controller mode.
SOUR:PRES:STAB[?] [stab]	Read or set the 4322 stability criteria.
STAT:OPER:COND?	Read the operation register
STAT:OPER:ENAB[?] [flags]	Read or set the operation enable mask
STAT:OPER:EVEN?	Read changes in the operation register
SYST:BAR:CHEC:RES	Resets existing A150K sensor “BaroCheck” status.
SYST:BEEP:IMM	Beep the system beeper.
SYST:VER:LOGIC?	Read the programmable logic versions.
SYST:COMM:GPIB:SELF:ADDR[?] [addr]	Read or set the 4322 device GPIB address.
SYST:DATE[?] [yyyy,mm,dd]	Read or set the System Date.
SYST:ERR?	Read the most resent error from the error queue.
SYST:HOURL?	Gets the operation time hour meters
SYST:KLOC[?] [0 1]	Locks or unlocks the system keypad.

Table 5-2, List of Alphabetical Commands (cont.)

Command	Quick Description
SYST:TIME[?] [hh,mm,ss]	Read or set the System Time.
SYST:TIM:COUN[?]	Get the elapsed seconds since power up
SYST[x]:VER:THM?	Read a sensor's firmware version.
UNIT:PRESSure[?] [unit]	Read or set the pressure units
UNIT:LENG[?] [unit]	Read or set the head height units
UNIT:TEMP[?] [n]	Read or set the display temperature units.

### Remote Command Format

Each command description provides the structure (short and long format), a description of the command purpose, a command example, an example of what the command returns (as applicable to query commands), and notes specific to the command. The following apply to each group of commands:

- Numeric data, specified by the mnemonic, <num>, uses ASCII characters to represent numbers. Numbers may contain a plus or minus ('+' or '-') sign, decimal point ('.'), and exponent ('E' or 'e') with its sign. If a fractional component is received when only an integer is required, the number is rounded to the nearest integer without any resulting error message. Unit suffixes, such as pressure units can be appended to numeric parameters and are accepted without error but ignored.
- Unrecognized commands or commands with incorrect syntax or invalid parameters generate error messages in the error queue.
- <> indicates a required parameter.
- [ ] indicates optional parameters or command text.
- ( ) indicates a group of parameters that must be used together.
- '|' indicates alternate parameter values.
- <n> indicates a number is required.
- <num> indicates numeric value is required.
- <bool> indicates a Boolean value (0 or 1) is required. The mnemonics OFF and ON are also accepted for 0 and 1, respectively.
- <par> indicates a parameter name is required.
- <yyyy> indicates a four digit number is required.
- <mm> indicates a one or two digit number is required.
- <dd> indicates a one or two digit number is required.
- <hour> indicates a one or two digit number is required.
- <minute> indicates a one or two digit number is required.
- <second> indicates a one or two digit number is required.



## Common and Status Commands

The 4322 supports a set of commands that are common to all instruments that conforms to the IEEE standard 488.2. In this section, each of these common and status commands are described and contains an example for reference.

### *\*CLS*

Clear the status registers, the communication buffers and the error queue.

Example: \*CLS

### *\*ESE[?]*

Read or set the Standard Event Status Enable Register (see “488.2 Status System” on page 5-19).

Example: \*ESE?

Response: 255

Set Example: ESE 60

### *\*ESR?*

Read the Standard Event Status Register (see “488.2 Status System” on page 5-19).

Example: \*ESR?

Response: 32

### *\*IDN?*

Gets manufacturer, model number, Calibrator and the four sensor serial numbers, firmware version, processor, and main-board logic versions.

Example: \*IDN?

Response: FLUKE, 4322,1001,1987023,1987014,1987012,1987030,1.4.0.418,E.00a,B.11f

### *\*OPT?*

Read the optional hardware that is installed. This command is a read-only command and returns the state of the GPIB interface.

Example: \*OPT?

Response: IEEE-488:0

### *\*RST*

Reset the Controller to a known state. This resets most all of the user settings (units, modes, etc.) to defaults. This does not affect calibration coefficients, test reports, or test definitions.

Example: \*RST

### *\*TST?*

Reads the Controller power up self-test status. A response of ‘0’ indicates the Controller turned on OK. A response other than ‘0’ indicates there was an error on start up.

Example: \*TST?

### *\*RSE[?]*

Read or set the Ready Status Enable Register (see “488.2 Status System” on page 5-19).

Example: \*RSE?

Response: 3

Set Example: \*RSE 1

**\*RSR?**

Read the Ready Status Register (see “488.2 Status System” on page 5-19).

Example: \*RSR?

Response: 7

**\*SRE[?]**

Read or set the Service Request Enable Register (see “488.2 Status System” on page 5-19).

Example: \*SRE?

Response: 128

Set Example: \*SRE 28

**\*STB?**

Read the Standard Event Status Register (see “488.2 Status System” on page 5-19).

Example: STB?

Response: 16

**Specific Commands**

The commands specific to the Controller supports its specific features and conform to the format and syntax of the SCPI standard.

**CALx:PRES:DATA[?]** [ $C_{0,A}$ ,  $C_{1,A}$ ,  $C_{0,B}$ ,  $C_{1,B}$ ,  $C_{0,C}$ ,  $C_{1,C}$ ] or  
**CALIBRATEx:PRESSURE:DATA[?]** [ $C_{0,A}$ ,  $C_{1,A}$ ,  $C_{0,B}$ ,  $C_{1,B}$ ,  $C_{0,C}$ ,  $C_{1,C}$ ]

Read or set the user calibration coefficients  $C_0$  (Pa) and  $C_1$  for the three separate sensor elements (A, B, and C) of the specified sensor. The entered values are all numeric. The query operator should always be used with this command to: (1) ensure that the execution is complete and (2) to make sure a response has been sent before another command is sent.

These values are stored within the nonvolatile memory inside the sensor, so this command should be used cautiously. Suffix ‘x’ specifies the sensor to access:

x:	1	2	3	4	5
Sensor	10 kpsig	1500 psig	100 psig	21.5 psia	Barometer

*Note*

*The Barometer only has a single measurement element, and will reply with only  $C_0$  and  $C_1$*

Read Example: CAL1:PRES:DATA?

Response: 23,1.002345 , -13,1.002445 , 103,1.002011

Set Example: CAL2:PRES:DATA 0.002,1.0012,-0.01,1.004,0.1,1.0005

Barometer Read Example: CAL5:PRES:DATA?

Barometer Response: 4.1,1.00032

Barometer Set Example: CAL5:PRES:DATA 1.10,1.001

***CALx:PRES:DATE[?] [yyyy,mm,dd] or CALIBRATEx:PRESSURE:DATE[?] [yyyy,mm,dd]***

Read or set the user calibration date for the specified sensor. The entered values are all numeric and “yyyy” is a four digit year (2000-2135). The default value is 2000. “mm” is a two digit month (1-12), and “dd” is a two digit day (1-31). This date should be set whenever the calibration coefficients are modified using the **CALx:PRES:DATA** command. The query operator should always be used with this command to: (1) ensure that the execution is complete and (2) to make sure a response has been sent before another command is sent.

These values are stored within the nonvolatile memory inside the sensor, so this command should be used cautiously. Suffix ‘x’ specifies the sensor to access:

<i>x:</i>	<i>1</i>	<i>2</i>	<i>3</i>	<i>4</i>	<i>5</i>
Sensor	10 kpsig	1500 psig	100 psig	21.5 psia	Barometer

Read Example: CAL2 : PRES : DATE ?

Response: 2010 , 05 , 24

Set Example: CAL2 : PRES : DATE 2011 , 12 , 30

***CALx:PRES:SER? or CALIBRATEx:PRESSURE:SERIAL?***

Read the serial number of the sensor. Suffix ‘x’ specifies the sensor to access:

<i>x:</i>	<i>1</i>	<i>2</i>	<i>3</i>	<i>4</i>	<i>5</i>
Sensor	10 kpsig	1500 psig	100 psig	21.5 psia	Barometer

Read Example: CAL3 : PRES : SER ?

Response: 01987041

***CALC:LIM:LOW[?] [limit] or CALCULATE:LIMIT:LOWER[?] [limit]***

Read or set the lower limit for requesting set-points in the current displayed pressure units. Pressure generation will abort and an alarm will sound if the pressure is below this limit.

Read Example: CALC1 : LIM : LOW ?

Response: 5 . 00

Set Example: CALC : LIM : LOW 110

***CALC:LIM:UPP[?] [limit] or CALCULATE:LIMIT:UPPER[?] [limit]***

Read or set the upper limit for set-points in the current displayed pressure units after they are requested. Pressure generation will abort and an alarm will sound if the pressure is above this limit. This limit should be used to prevent over pressure of a device under test.

Read Example: CALC1:LIM:UPP?

Response: 10500.00

Set Example: CALC:LIM:UPP 1100

***INP:TYPE[?] [type] or INPUT:TYPE[?] [type]***

Read or set the supply input type. This specifies what type of supply will be used within the pressure range where either input type is valid. *type* can be INTERNAL, INTERN, EXTERNAL, or EXTERN. This setting only applies to the span of pressure that both INTERNAL (pump) and EXTERN (external gas source) can operate within (typically 4 psi to 300 psi)

Read Example: INP:TYPE?

Response: INTERNAL

Set Example: INP:TYPE EXTERNAL

***MEAS[x]:PRES? or MEASURE[x]:PRESSURE?***

Reads the pressure for the active or for the specified sensor. The response is sent in the current pressure measurement unit and reference mode in the currently set resolution when the next measurement is available. The Barometer pressure response is always in absolute mode when set to full resolution.

If a sensor is not specified using the suffix 'x', then the pressure of the currently active sensor is replied. Otherwise, the suffix 'x' specifies the sensor to access:

<i>x:</i>	<i>1</i>	<i>2</i>	<i>3</i>	<i>4</i>	<i>5</i>
Sensor	10 kpsig	1500 psig	100 psig	21.5 psia	Barometer

Inactive sensors may be at atmospheric pressure. Care must be used when the sensor with the suffix 'x' is selected as the response may not reflect the true pressure of the Controller.

Example: MEAS: PRES?

Response: 100.02

Example: MEAS5: PRES?

Response: 13.9234

***MEAS[x]:PRES:ALL? or MEASURE[x]:PRESSURE:ALL?***

Reads the last known pressure of all three elements of the active or the specified sensor followed by the Barometer measurement. The response is sent in the current pressure measurement unit and reference mode in the currently set resolution when the next measurement is available. The pressures are typically used for recalibration of the sensors

If a sensor is not specified with the suffix 'x', then the pressure of the currently active sensor is replied. Otherwise, the suffix 'x' specifies the sensor to access:

<i>x:</i>	<i>1</i>	<i>2</i>	<i>3</i>	<i>4</i>
Sensor	10 kpsig	1500 psig	100 psig	21.5 psia

Example: MEAS2: PRES: ALL?

Response: 100.020, 100.024, 100.013, 14.2354

**MEAS:PRES:SLEW? or MEASURE:PRESSure:SLEW?**

Reads the slew rate for the active sensor. The response is sent in the current pressure measurement unit per second when the next measurement is available.

Example: MEAS : PRES : SLEW?

Response: 0 . 28

**MEAS[x]:ZERO:VAL[?] [ $P_{z,A}$ ,  $P_{z,B}$ ,  $P_{z,C}$ ] or MEASURE[x]:ZERO:VALUE[?] [ $P_{z,A}$ ,  $P_{z,B}$ ,  $P_{z,C}$ ]**

Read or set the zero values for the three measurement elements (A, B, and C) within the specified sensor. These values are in the selected units in full resolution and are determined and set by the autozero routine when autozero is enabled and the Controller vented and stable. The suffix 'x' specifies the sensor to access:

x:	1	2	3	4
Sensor	10 kpsig	1500 psig	100 psig	21.5 psia

Read Example: MEAS : ZERO : VALUE?

Response: -16105 . 5 , -16580 . 6 , -21517 . 1

Set Example: MEAS : ZERO : VALUE 0 , 0 , 0

**MEAS:ZERO:STAT[?] [0/1] or MEASURE:ZERO:STATE[?] [0/1]**

Read or set the autozero state. When set to '1', autozero will be enabled and will zero the sensors when the Controller is vented and stable. When set to '0', autozero will be disabled and the zero values for the three measurement elements (A, B, and C) will not be updated. Autozero is always enabled on power up regardless of its prior state.

Read Example: MEAS : ZERO : STAT?

Response: 1

Set Example: MEAS : ZERO : STAT 0

**OUTP:STAT[?] [0/1] or OUTPUT:STATE[?] [0/1]**

Read or set the current operation state of the Controller. A "0" idles the Controller for measurement use only. '1' resumes control at the last specified set-point. The response to the query form indicates if the controller is active ('1') or idle ('0').

Read Example: OUTP : STAT?

Response: 0

Set Example: OUTP : STAT 1

**OUTP:MODE[?] [mode] or OUTPUT:MODE[?] [mode]**

Read or set the current controller operating mode. 'mode' is the selected mode:

Mode	Description
MEASURE	Idles Controller until a new set-point is specified or control is restarted.
CONTROL	Restart control at the last specified set-point.
VENT	Vents the Controller.

Read Example: OUTP : MODE?

Response: VENT

Set Example: OUTP : MODE MEAS

***SENS:PRES:RES[?] [res] or SENSE:PRESSURE:RESOLUTION[?] [res]***

Read or set the pressure resolution with *res* in % of reading as indicated on the front panel.

Range = {1.0000 - 0.0001 %}

Read Example: SENS : PRES : RES ?

Response: 0 . 0100

Set Example: SENS : PRES : RES 0 . 001

***SENS:PRES:MODE[?] [mode] or SENSE:PRESSURE:MODE[?] [mode]***

Read or set the pressure measurement mode where '*mode*' can be set to ABSOLUTE, GAUGE, or VACUUM.

Read Example: SENS : PRES : MODE ?

Response: ABSOLUTE

Set Example: SENS : PRES : RES GAUGE

***SENS:PRES:RANG? [range] or SENS:PRESSURE:RANGE? [range]***

Read the range of the currently active sensor or select which sensor is currently active in the current units and measurement mode. The active sensor is the only sensor that can be selected only when it is idle (not generating pressure) and the pressure is within the specified range of the sensor. The Controller will automatically override a manually specified sensor selection when a new target is set or if pressure increased above the specified range of the sensor.

Read Example: SENS : PRES : RANGE ?

Response: 1500 . 0

Set Example: SENS : PRES : RANGE 50

Response: 100 . 0 (range of most suitable sensor for range request is replied)

***SENS:PRES:REF:HEIG[?] [head] or  
SENSE:PRESURE:REFERENCE:HEIGHT[?] [head]***

Read or set the height difference between the Controller and the UUT used for the head-height correction. *head* is in the current length units and is relative to the Controller.

Read Example: SENS : PRES : REF : HEIG

Response: 10 . 0

Set Example: SENS : PRES : REF : HEIG 3

***SENS:PRES:REF:MED[?] [gas] or SENSE:PRESSURE:REFERENCE:MEDIUM[?] [gas]***

Read or set the gas medium used for the head correction between the Controller and the UUT. '*gas*' is either N2, HE, or AIR.

Read Example: SENS : PRES : REF : MED

Response: N2

Set Example: SENS : PRES : REF : MED AIR

*SOUR:PRES:LEV:IMM:VENT[?] [0|1] or  
SOURCE:PRESSURE:LEVEL:IMMEDIATE:VENT[?] [0|1]*

Read or set the vent status of the Controller. Read of the status will only indicate vented ('1') once the Controller is vented and has zeroed once (if autozero is enabled).

Read Example: SOUR : PRES : LEV : IMM : VENT?  
Response: 1  
Set Example: SOUR : PRES : LEV : IMM : VENT 1

*SOUR:PRES:LEV:IMM:AMPL [?] [targ] [, rate] or  
SOURCE:PRESSURE:LEVEL:IMMEDIATE:AMPLITUDE:[?] [targ] [, rate]*

Read or set the set-point to control pressure to. If a new target is set, it will abort the current process and control pressure to the set-point *targ* in the current measurement units and mode. This happens only if *targ* is within acceptable limits of the currently active sensor. A *targ* value of '0' will vent the 4322 when in gauge mode. Use the RDY and NRDY flags of the "RSR" register using the *\*RSR?* query to determine when a new target has been reached and is within the ready criteria. The optional rate argument attempts to reach the setpoint at the specified fixed rate (unit/sec) and abort control once the setpoint is reached. If the optional rate argument is not given, then normal control methods are used to reach and maintain the setpoint.

Read Example: SOUR : PRES : LEV : IMM : AMPL?  
Response: 100  
Set Example: SOUR : PRES : LEV : IMM : AMPL 50  
Set Example (fixed rate): SOUR : PRES : LEV : IMM : AMP 100, 10

*SOUR:PRES:MODE[?] [mode] or SOURCE:PRESSURE:MODE[?] [mode]*

Read or set the Controller mode. Mode can be set to STATIC, JOG, or DYNAMIC. This only sets the mode and it does not start active control.

Read Example: SOUR : PRES : MODE?  
Response: STATIC  
Set Example: SOUR : PRES : MODE DYN

*SOUR:PRES:STAB[?] [stab] or SOURCE:PRESSURE:STABILITY[?] [stab]*

Read or set the Controller control stability criteria that is required for a control set-point to be "ready". *stab* is in percent of set-point.

Read Example: SOUR : PRES : STAB?  
Response: 0.500  
Set Example: SOUR : PRES : STAB .25

***SOUR:PRES:CONT[?] [hold] or SOURCE:PRESSURE:CONTROL[?] [hold]***

Read or set the Controller control dead-band for control to achieve a steady state within. *hold* is in percent of set-point.

Read Example: SOUR : PRES : CONT ?

Response: 0 . 200

Set Example: SOUR : PRES : CONT . 1

***STAT:OPER:COND? or STATUS:OPERATION:CONDITION***

Read the operation register (see “488.2 Status System” on page 5-19).

Read Example: STAT : OPER : COND ?

Response: 0

***STAT:OPER:ENAB[?] [flags] or STATUS:OPERATION:ENABLE[?] [flags]***

Read or set the operation enable mask. Setting a specific bit(s) within the mask will cause the Operation Summary bit of the Status register to be set when changes in the specific events occur. (see “488.2 Status System” on page 5-19).

Read Example: STAT : OPER : ENAB ?

Response: 1

Set Example: STAT : OPER : ENAB 10

***STAT:OPER:EVEN? or STATUS:OPERATION:EVENT?***

Read changes in the operation register (see “488.2 Status System” on page 5-19).

Read Example: STAT : OPER : EVEN ?

Response: 8

***SYST:BAR:CHEC:RES or SYSTEM:BAROMETER:CHECK:RESET***

Resets the existing A150K sensor “BaroCheck” status and adjustments, removing any existing BaroCheck notifications, limitation and adjustments to the indicated pressure. This command writes to A150K sensor’s nonvolatile memory, so this command should be used sparingly.

Example: SYST : BAR : CHEC : RES

***SYST:BEEP:IMM or SYSTEM:BEEP:IMMEADIATE***

Beep the system beeper. The system beeper should make an audible sound in response to this command.

Example: SYST : BEEP : IMM



***SYST:VER:LOGIC? or SYSTEM:VERSION:LOGIC?***

Read the programmable logic versions. First field is the microprocessor version and the second is the main board version.

Example: SYST:VER:LOGIC?

Response: E.00a, B.11F

***SYST:COMM:GPIB:SELF:ADDR[?] [addr] or  
SYSTEM:COMMUNICATE:GPIB:SELF:ADDRESS[?] [addr]***

Read or set the GPIB address the Controller uses for communication with a host computer. *addr* can be 1 to 31. If the address is changed and the command is also a query, the response will be to the new address.

Read Example: SYST:COMM:GPIB:SELF:ADDR?

Response: 10

Set Example: SYST:COMM:GPIB:SELF:ADDR 5

***SYST:DATE[?] [yyyy,mm,dd] or SYSTEM:DATE[?] [yyyy,mm,dd]***

Read or set the system date setting with numbers separated by commas (yyyy,mm,dd).

Read Example: SYST:DATE?

Response: 2007,05,24

Set Example: SYST:DATE 2007,05,24

***SYST:ERR? or SYSTEM:ERROR?***

Read the most resent error from the error queue. This command response reports the errors in the error queue. The *\*CLS* command clears this queue.

Example: SYST:ERR?

Response: command protected

***SYST:HOUR? or SYSTEM:HOURS?***

Gets the current elapsed hours of operation for four activities:

1. Hours the internal pump has operated.
2. Hours not vented since sensor calibration.
3. Hours not vented and at pressure.
4. Hours turned on.

Read Example: SYST:HOUR?

Response: 4, 245, 1022, 3211

***SYST:KLOC[?] [0/1] or SYST:KLOCK[?] [0/1]***

Locks or unlocks the system keypad (except for the ABORT key). The keypad is always unlocked when the Controller is powered up. 'n' = 0/1 for unlock/lock.

Read Example: SYST:KLOCK?

Response: 1

Set Example: SYST:KLOC 1

***SYST:TIME[?] [hh,mm,ss] or SYSTEM:TIME[?] [hh,mm,ss]***

Read or set the System Time (24 hour time format only).

Range: hh = {0 to 23}, mm = {0 to 59}, ss = {0 to 59}

Response: 23, 51, 05

Set Example: SYST:TIME 14, 15, 05

***SYST:TIM:COUN? or SYSTEM:TIMER:COUNT?***

Gets the elapsed seconds since the unit has been turned on.

Read Example: SYST:TIM:COUN?

Response: 2398

***SYST[x]:VER:THM? or SYSTEM[x]:VERSION:THM?***

Read the firmware version installed in the sensor.

Specifies the sensor to access: x: 1 2 3 4

Sensor 10 kpsig 1500 psig 100 psig 21.5 psia

Example: SYST4:VER:THM?

Response: 0.19

***UNIT:PRES[?] [unit] or UNIT:PRESSURE[?] [unit]***

Read or set the pressure units displayed on the UI and one the remote interface. Please see the user interface section of the Operators Manual for the supported units.

Read Example: UNIT:PRES?

Response: psi

Set Example: UNIT:PRES kPa

***UNIT:LENG[?] [unit] or UNIT:LENGth[?] [unit]***

Read or set the head height units. Possible arguments are “cm” or “in”.

Read Example: UNIT:LENG?

Response: in

Set Example: UNIT:LENG cm

***UNIT:TEMP[?] [n] or UNIT:TEMPERATURE[?] [n]***

Read or set the display temperature units, where “n” is “C” or “F”.

Default: C.

Read Example: UNIT:TEMP?

Response: C

Set Example: UNIT:TEMP F

***488.2 Status System***

The Status System lets the operator monitor various Controller operating conditions. 8 bit or 16 bit registers are used to access the conditions, where each individual bit serves a specific function. Masks can be set up to enable the desired conditions to be checked, or all conditions can be read and deciphered as needed. The GPIB488 interface can be set up to respond to enabled conditions by asserting the SRQ signal of the GPIB488 interface.

The Host Computer and its program must be properly set up to respond to SRQ occurrences to work with this feature. The operator should be familiar with the standard GPIB488.2 status system before using these registers. Listed below are the register descriptions and the commands used to access them. The decimal weighting is indicated with the braces, as this is the value used with the commands them.

### Status Byte Register

This register reflects the general top level state of the Controller and is typical of most instruments.

OPER Bit7 (128)	RQS/MSS Bit6 (64)	ESB Bit5 (32)	MAV Bit4 (16)	N/A Bit3 (8)	ERROR Bit2 (4)	N/A Bit1 (2)	RSR Bit0 (1)
--------------------	----------------------	------------------	------------------	-----------------	-------------------	-----------------	-----------------

The bits of this register are determined by the response queue, error queue, the Standard Event Status Register (ESR) and the status system as shown in Figure 5-1.

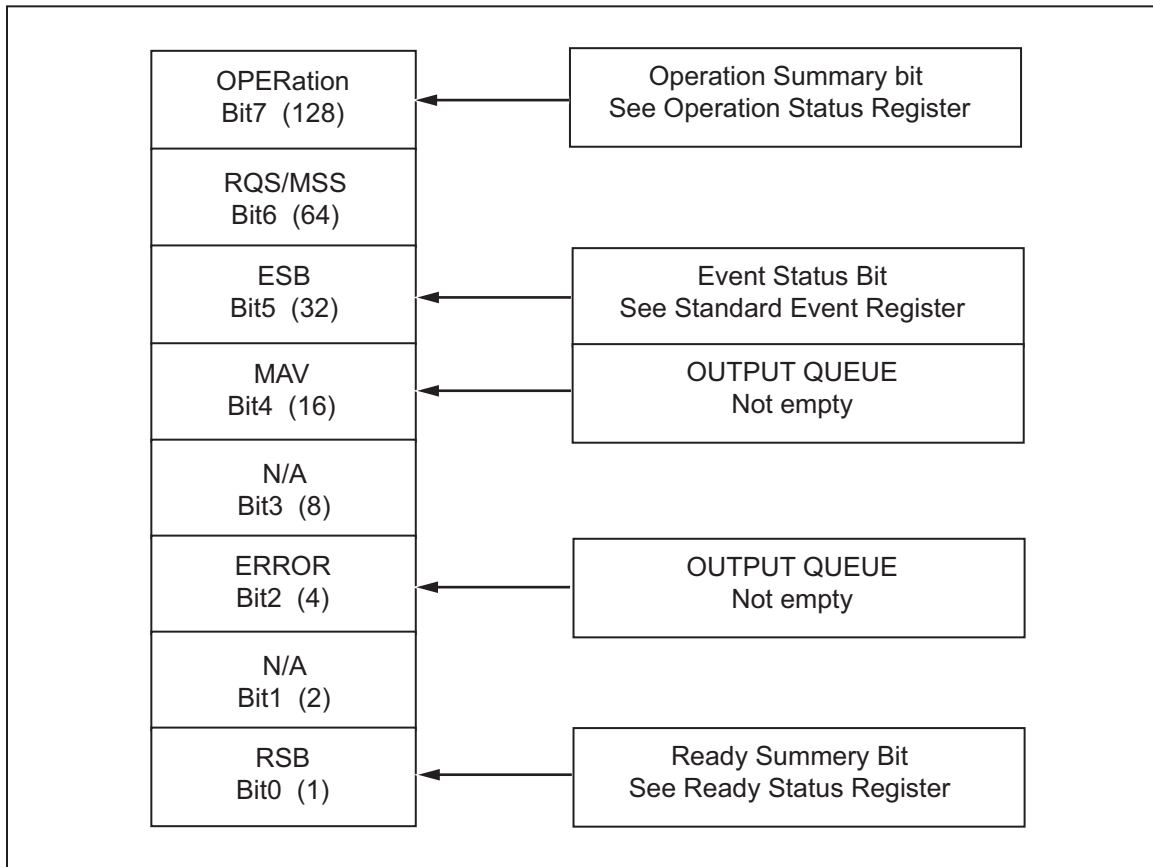

Figure 5-1. Status Register

gxj087.eps

The Status Byte Register can be read using the “\*STB?” query, or by performing a serial poll on the GPIB488 interface. If read with a serial poll, then Bit 6 is the RQS. If the “\*STB?” query is used, then bit 6 is the MSS bit. All of the other bits are common to both types of query.

Each of these status bits can cause a SRQ to occur when used with the GPIB488 interface. The Service Request Enable Register (“\*SRE” command ) determines which of these flags are able to assert the SRQ line. This enable register has a matched set of bits that each enables the designated bit to cause a SRQ, except for the RQS/MSS bit(s) which cannot cause a SRQ. If you set this register to 20 (\$14 hex), an SRQ will occur if the MAV or the ERROR bit are set. The description of these bits are given as:

**OPER: Operational Event Register Summary Bit (Bit 7)**

This bit is set and clears by the Operational Summary bit whose status is derived from the Operation Status Register (See the “STAT:OPER:” commands)

**RQS: Requested Service (Bit 6)**

Indicates that the SRQ line of the IEEE-488 interface has been asserted by the Controller. This bit is cleared when a serial poll is performed on the Instrument, and is a part of the status byte register when read with a serial poll. This bit only applies when used with the GPIB488 interface.

**MSS: Master Summary Status (Bit 6)**

Indicates that an event or events occurred that caused the Controller to request service from the Host, much like the RQS bit. Unlike the RQS bit, it is read-only and can be only cleared when the event(s) that caused the service request are cleared.

**ESB: Event Summary Bit (Bit 5)**

Indicates if an enabled bit in the Standard Event Status Register became set.

**MAV: Message Available Bit (Bit 4)**

Indicates that at least one reply message is waiting in the response queue.

**QUES: QUEStionable event register summary bit (Bit 3)**

This bit is not supported.

**ERR: Error Queue not empty (Bit 2)**

Indicates that at least one command error message is waiting in the error message queue. Use the “SYST:ERR?” query to get these messages.

**RSB: Ready Summery Bit (Bit 0)**

Indicates that an enabled bit in the Ready Status Register became set. Use the “\*RSE” command to enable the desired events.

### Standard Event Register

The Controller contains a 8 bit Standard event register (ESR) that reflects specific events. Enabled events in this register will set or clear the ESB bit of the Status Byte Register.

PON Bit 7 (128)	URQ Bit 6 (64)	CMD Bit 5 (32)	EXE Bit 4 (16)	DDE Bit 3 (8)	QYE Bit 2 (4)
--------------------	-------------------	-------------------	-------------------	------------------	------------------

This register can be read using the “\*ESR?” query. Each of these status bits can set the ESB bit of the status byte register, which will cause an SRQ to occur when the GPIB488 interface is used (if the ESB bit is enabled to do so). The Standard Event Status Enable Register (“\*ESE” command) determines which of these flags are able to assert the ESB bit. The description of these bits are given as:

**PON: Power On - Bit 7 (128)**

Indicates that the power has been cycled since the last time this bit was read or cleared.

**URQ: User Request - Bit 6 (64)**

Indicates that the Controller was set to local operation manually from the front panel by the user.

**CMD: Command Error - Bit 5 (32)**

Indicates that a remote command error has occurred. A command error is typically a syntax error in the use of a remote command.

**EXE: Execution Error - Bit 4 (16)**

Indicates if a remote program message cannot be processed due to device related condition.

**DDE: Device Dependent Error - Bit 3 (8)**

Indicates that an internal error has occurred in the Controller such as a transducer failure.

**QYE: Query Error - Bit 2 (4)**

Indicates that an error has occurred in the protocol for program message communications. This is typically caused by a command that is sent to the Controller without reading a response that is waiting in the response queue.

### Ready Status Register

The Controller contains a Ready Status Register (RSR) that reflects measurement and pressure generation specific events. Enabled events in this register will set or clear RSB of the Status Byte Register.

MEAS Bit 2 (4)	NRDY Bit 1 (2)	NRDY Bit 0 (1)
-------------------	-------------------	-------------------

This register can be read using the “\*RSR?” query which returns the register status and clears the register. Each of these status bits can set the RSB bit of the Status Byte Register, which causes a SRQ to occur only if the RSB bit is enabled to do so. The Standard Event Status Enable Register (“\*RSE” program message ) determines which of these flags are able to assert the RSB bit. The description of these bits are given as:

**MEAS: New Measurement Ready Bit 2 (4)**

Indicates that the active sensor has a new measurement ready.

**NRDY: Generation Not Ready - Bit 1 (2)**

Set when the pressure has transitioned from Ready to Not Ready as defined by the control criteria.

**RDY: Generation Ready - Bit 1 (2)**

Set when the pressure has transitioned from Not Ready to Ready as defined by the control criteria.

### Operation Status Register

The 16 bit Operation Status Register reflects Controller specific events. Enabled events in this register will set or clear the Operational Event Register Summary Bit of the Status Byte Register Only 2 bits are used while the remaining 14 are reserved for future use:

CC <sub>A150K</sub> Bit 7 (128)	CC <sub>G700K</sub> Bit 6 (64)	CC <sub>G10M</sub> Bit 5 (32)	CC <sub>G70M</sub> Bit 4 (16)	Not used Bit 3 (8)	Busy Bit 2 (4)	NRDY Bit 1 (2)	RDY Bit 0 (1)
------------------------------------	-----------------------------------	----------------------------------	----------------------------------	-----------------------	-------------------	-------------------	------------------

This register can be read with the “STAT:OPER:COND?” query. Reading the status does not affect the state of these bits. Each of these status bits can set Operational Event Register Summary Bit of the Status Byte Register. This causes an SRQ to occur when with the GPIB488 interface only if the Operational Event Register Summary Bit is enabled to do so. The “STAT:OPER:ENAB” command determines which of these flags are able to assert the Operational Event Register Summary Bit. The description of these bits are given as:

- **RDY:** Set point Ready - Bit 0 (1)  
Set when the 4322 is actively executing a set-point and has made a transition from *Not Ready* to *Ready* as defined by the control criteria.
- **NRDY:** Set point Not Ready - Bit 1 (2)  
Set when the 4322 is actively executing a set-point and has made a transition from *Ready* to *Not Ready* as defined by the control criteria.
- **Busy:** The 4322 is busy executing a procedure. - Bit 2 (4)  
Set when the 4322 is actively executing a locally started procedure such as a UUT test, self-calibration or Baro-Check procedure. The bit is cleared when the procedure is complete or has been aborted.
- **CC<sub>G70M</sub>:** G70M sensor calibration check - Bit 4 (16)  
Set when the 4322 suspects that the G70M sensor may be out of calibration. This bit is cleared on power up or after the G70M calibration has been changed.
- **CC<sub>G10M</sub>:** G10M sensor calibration check - Bit 5 (32)  
Set when the 4322 suspects that the G10M sensor may be out of calibration. This bit is cleared on power up or after the G10M calibration has been changed.
- **CC<sub>G700K</sub>:** G700K sensor calibration check - Bit 6 (64)  
Set when the 4322 suspects that the G700K sensor may be out of calibration. This bit is cleared on power up or after the G700K calibration has been changed.
- **CC<sub>A150K</sub>:** G700K sensor calibration check - Bit 7 (128)  
Set when the 4322 suspects that the A150K sensor may be out of calibration. This bit is cleared on power up or after the A150K calibration has been changed.

### Remote Errors

Errors in the remote commands received by the Controller are placed into an error queue. The 488.2 status system can be used to check if the error queue is not empty, or the SYS:ERR? Query can be used to get the oldest entry (if any) in the error queue. The errors are in typical 488.2 format, using both standard 488.2 errors and errors specific to the Controller as listed in Table 5-3.

Table 5-3. Error Values

Error	Code
No Error	0
Command error	-101
Syntax error	-102
Invalid separator	-103
Parameter not allowed	-108
Missing parameter	-109
Command header error	-110
Header suffix out of range	-114
Suffix not allowed	-120
Invalid character data	-138
String data error	-150
Data out of range	-222
Illegal parameter value	-224



**Table 5-3. Error Values (cont.)**

<b>Error</b>	<b>Code</b>
Queue overflow	-350
Query error	-400
User defined coefficient cannot be 0	102
Not available with a gauge sensor	103
Not available with an absolute sensor	104
Not available with gauge units	106
Not available with absolute units	107
Pressure exceeds range maximum pressure	108
Numeric data not part of set	110
Numeric data length too great	111
Data length too great	120
String data not part of set	130
String data length too great	131
Pressure exceeds range upper limit	140
External device not detected	150
External device improperly configured	151
External device timeout error	152
Internal Sensor timeout	161
Barometer sensor timeout	181



# Chapter 6

## **Operator Maintenance and Troubleshooting**

<b>Title</b>	<b>Page</b>
Introduction.....	6-3
Fuse Replacement .....	6-3
Clean the Front Panels and Cases .....	6-5
Controller Identification .....	6-5
Controller Event Log .....	6-5
Reset Controller Settings .....	6-6
Nitrogen Cylinder Maintenance.....	6-6
Safety .....	6-6
Visual Inspection .....	6-7
External Cylinder Cleaning Procedure .....	6-7
Internal Cylinder Cleaning Procedure .....	6-8
Nitrogen Recharge Procedure.....	6-9
Controller Troubleshooting.....	6-11
Controller Fault Codes .....	6-11
Electrical Problems.....	6-13
Pressure Generation and Indication Problems.....	6-13
CPS and Quick-Connect Problems.....	6-14
Intensifier Troubleshooting.....	6-14
Electrical Problems.....	6-14
Pressure Selection and LED Indications .....	6-15
Abnormal Noises .....	6-15
Pressure Generation and Indication Problems.....	6-16
Valves and Quick-Connect Problems.....	6-16



## Introduction

This chapter contains maintenance tasks that can be performed by the operator such as general care, cleaning, fuse replacement, and Nitrogen Cylinder servicing. See the *4322 Service Manual* for maintenance and repair procedures that are to be performed by qualified maintenance personnel. See Chapter 7 for calibration procedures.

## Fuse Replacement

The Controller and Intensifier each have a fuse that protects from overcurrent. See Table 6-1 and Table 6-2.

### Warning

**To prevent possible electrical shock, fire, or personal injury, use only specified replacement parts.**

**Table 6-1. Controller Fuse**

Voltage Selector	Fuse	Fluke Part Number
100 V	FUSE,FUSE,5X20MM,1A,250V,SLOW	808055

**Table 6-2. Intensifier Fuse**

Voltage Selector	Fuse	Fluke Part Number
100 V	CONTRACT MFG ITEM, FUSE 5X20 5A S/B 250V	2077364

To replace a fuse (see Figure 6-1):

1. Disconnect the mains-power cord from the power-entry module.
2. Open the power-entry module and remove the fuse holder.
3. Replace the fuse with an exact replacement as listed in Table 6-1 and Table 6-2.

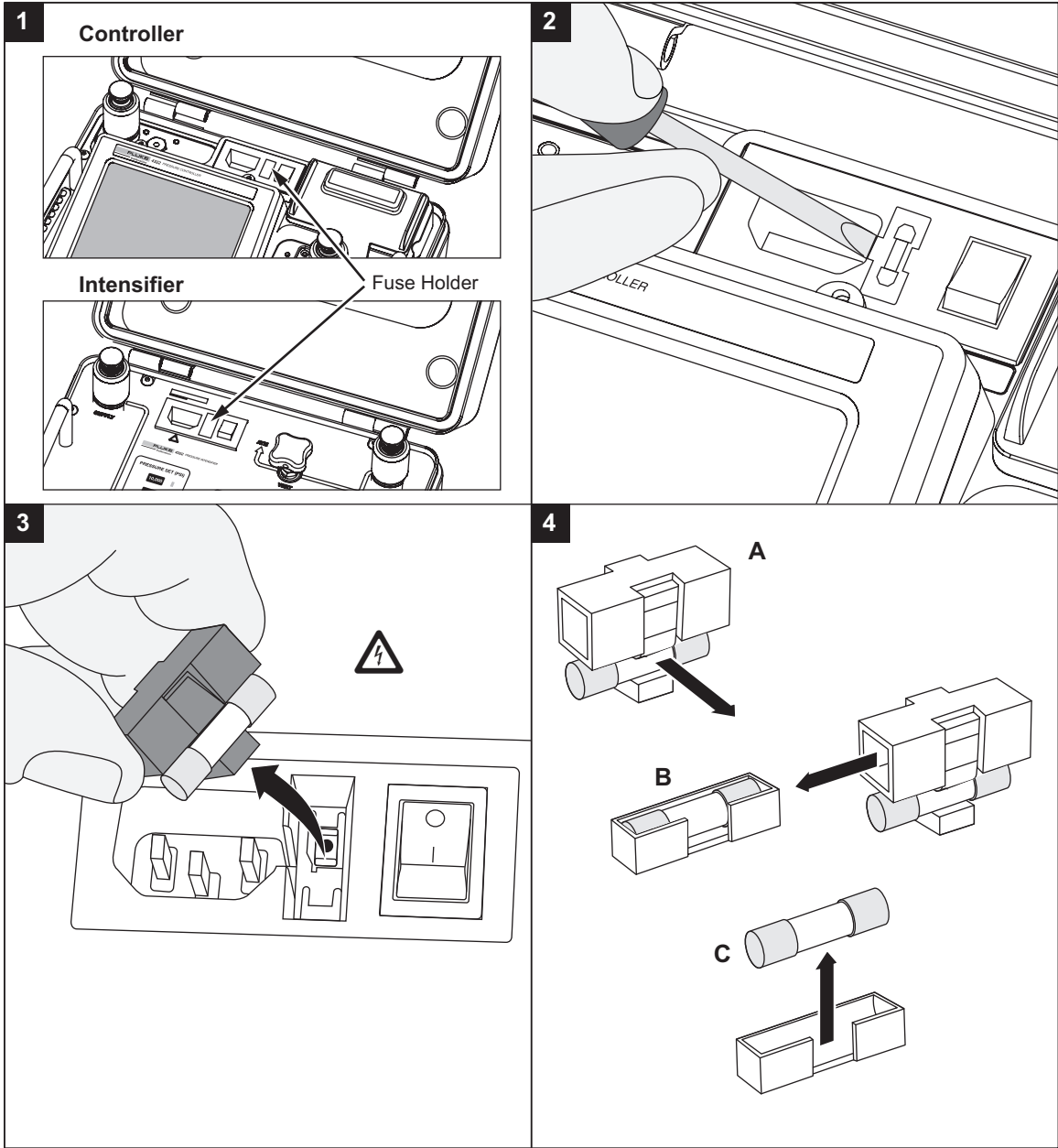

Figure 6-1. Fuse Replacement

gxj081.eps

## Clean the Front Panels and Cases

To clean the Calibrator, wipe it with a cloth that is lightly dampened with water or mild detergent. Do not use aromatic hydrocarbons, chlorinated solvents, or methanol based fluids.

## Controller Identification

The Controller identification (ID) is a setting that allows the maintenance personnel to set a custom identification string such as an asset or serial number. This number can be up to 10 characters and can consist of numerals and letters.

Set the Controller ID as follows:

1. Select **Settings** on the Main menu.
2. Select the **Internal** tab.
3. Select **ID** to open the ID menu.
4. Input a custom alpha-numeric ID (limit of 15 characters).
5. Push **OK** to save.

## Controller Event Log

The Event Log is an automated event recorder used by maintenance personnel to see if the Controller has experienced any failures, overpressures, or exceedences. Each recorded event has specific information on the event and contains a date and time stamp to indicate when the event occurred.

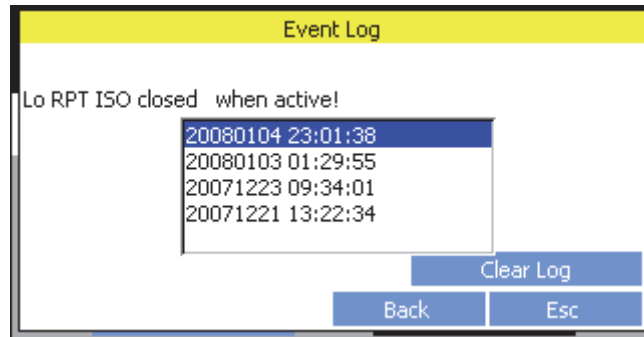

View the events in the Event Log as follows:

1. Select **Settings** on the Main menu.
2. Select the **Internal** tab.
3. Select **Event Log** to open the ID menu.

Clear the events in the Event Log as follows:

1. Select **Settings** on the Main menu.
2. Select the **Internal** tab.
3. Select **Event Log** to open the ID menu.
4. Select **Clear Log**.

## Reset Controller Settings

The Controller has a series of settings reset functions that allows the operators or maintenance personnel reset or clear data from the Controller. Table 6-3 shows the five reset functions available along with a brief description.

Table 6-3. Reset Functions

Reset Function	Description
Settings	Resets all settings with the exception of the calibration coefficients.
Test Definitions	Resets test files and the UUT Names stored in the NV memory.
UUT Names	Resets just the UUT Names stored in the NV memory.
Test & Self-Cal Reports	Resets test reports and all Self-Cal reports stored in the NV memory.
All	Performs a reset of all of the reset functions listed above.

Run a reset function as follows:

1. Select **Settings** on the Main menu.
2. Select the **Internal** tab.
3. Select **Resets**.
4. Select a function to clear then select **Yes** to confirm action.

### Caution

**Data is permanently deleted when performing some reset functions. Before performing a reset, understand completely what setups, results, and settings are being affected, and verify that it is OK to proceed.**

## Nitrogen Cylinder Maintenance

The Nitrogen Cylinder (the Cylinder) is used to supply very high pressure gas and should be handled with care, especially when it is filled. The Cylinder must be regularly inspected and hydrostatically tested every 5 years.

### Safety

Do not use, handle, or service the Cylinder until the safety information below is read and understood.

### Warnings

**For safe operation and maintenance of the product and to prevent injury:**

- **Do not ship the Cylinder while pressurized or with the regulator assembly attached.**
- **Do not alter or obscure the Cylinder markings.**
- **Do not allow your Cylinder to roll around while traveling.**
- **Do not drop, strike or heat the Cylinder.**
- **Do not expose your Cylinder to excessive heat.**



- Do not attempt to modify the threads or force a valve into the Cylinder.
- Do not attempt to remove metal from the Cylinder by any means as it will render the cylinder unsuitable for the rated pressure containment.
- Do not modify the Cylinder by adding extra openings for gauges or filling ports.
- Do not re-paint the Cylinder with paints that require baking at elevated temperatures.
- Only use air-drying paints. Do not use caustic paint strippers or corrosive cleaners as they will damage the Cylinder.
- Do not use the Cylinder for anything other than its intended purpose.

### **Visual Inspection**

The visual inspection makes sure the Cylinder is in good operating condition before it is used. Never use the Cylinder if it shows signs of corrosion, gouges, indents, bulges, heat damage or if it has been dropped or otherwise damaged.

Visually inspect the Cylinder before use as follows:

1. Check to make sure the Cylinder has been hydrostatically tested in the last 5 years.
2. Check the internal pressure to make sure it is within proper range (500 psig to 2,000 psig).
3. Check for leaks. In the unlikely event that a leak is detected, under no circumstances should the cylinder be re-filled until repaired.

### **External Cylinder Cleaning Procedure**

Clean the outside of the Nitrogen Cylinder with soap and water, a solvent wipe, or a nonmetallic scrub pad.

#### **⚠ Warning**

**To prevent damage to the project or personal injury, make certain that the cleaning product used is specifically marked with “suitable for aluminum”.**

### **Internal Cylinder Cleaning Procedure**

Clean the inside of the Nitrogen Cylinder as follows:

#### **⚠ Warning**

**To prevent personal injury, keep the threads and inside of the cylinder dry and free from oil, dirt or other contaminants.**

**For oil, grease, and lubricants:**

#### *Note*

*Complete the process without a break. Never leave cylinder freestanding with water.*

1. Mix together 1 tablespoon of liquid dish wash detergent to 1 gallon of tap water to make a soapy solution.
2. Pour the soapy solution into the cylinder and shake to agitate the water.
3. Rinse several times with tap water then rinse twice with demineralized or soft water.
4. Steam clean and dry the cylinder with clean compressed air.

#### **⚠ Caution**

**To prevent damage to the product, make sure the cylinder is completely dry before installing the regulator.**

**For corrosion:**

1. Mix together two to three cups of aluminum oxide tumbling chips to two quarts of soft water and one teaspoon of liquid washing detergent.
2. Pour the oxide chip mixture into the cylinder.
3. Use a tumbling machine to tumble the cylinder at 25 rpm to 35 rpm for 10 minutes with a wet detergent aluminum oxide chip combination.
4. Rinse cylinder completely with warm tap water (or soft water if the tap water is hard).
5. Steam clean and dry the cylinder with clean compressed air.

#### **⚠ Caution**

**To prevent damage to the product, make sure the cylinder is completely dry before installing the regulator.**

### **Nitrogen Recharge Procedure**

Use the procedure in this section to recharge the Cylinder. It is recommended that each operator write a comprehensive procedure that contains amplified instructions that includes specific steps for their filling apparatus.

#### **⚠ Warning**

**To prevent injury:**

- **Do not over pressurize the Nitrogen Cylinder. Maximum pressure of the Cylinder is 2,000 psig.**
- **Never fill a Cylinder that has the safety relief device altered in any manner.**
- **Never fill a Cylinder that is outside its periodic inspection and retest period.**
- **Never modify the Cylinder in any way or add attachments that are not authorized. Unauthorized modifications are illegal and could render the cylinder dangerous.**
- **Before the Cylinder is recharged, visually inspect the Cylinder as instructed in “Visual Inspection” section. Verify that the Cylinder has a working pressure (PW) stamped on the crown that will not be exceeded by the filling apparatus.**

Recharge the Cylinder with nitrogen as follows (see Figure 6-2):

1. Connect a filling regulator with a built-in safety relief valve set to 2,000 psi, to the fill adapter located in the Accessory Kit. Connect the nitrogen source to the filling regulator.
2. Connect the fill adapter to the Cylinder. Remove the Nitrogen Cylinder Regulator if it is installed. See Figure 6-2.

#### **⚠ Warning**

**To prevent injury to personnel or damage to equipment, do not over pressurize the Nitrogen Cylinder. Maximum pressure of the Cylinder is 2,000 psig.**

3. Close the bleed valve.
4. Open the Cylinder main shutoff.
5. Open the pressure valve on the nitrogen source and slowly fill the Cylinder to 2,000 psig or less.
6. Once the Cylinder reads 2,000 psig or is at the desired pressure <2,000 psig, close the pressure valve on the nitrogen source and close the Cylinder main shutoff.
7. Open the bleed valve to vent the nitrogen from the fill regulator.
8. Disconnect the filling regulator and the fill adapter.
9. Reconnect the Nitrogen Cylinder Regulator.

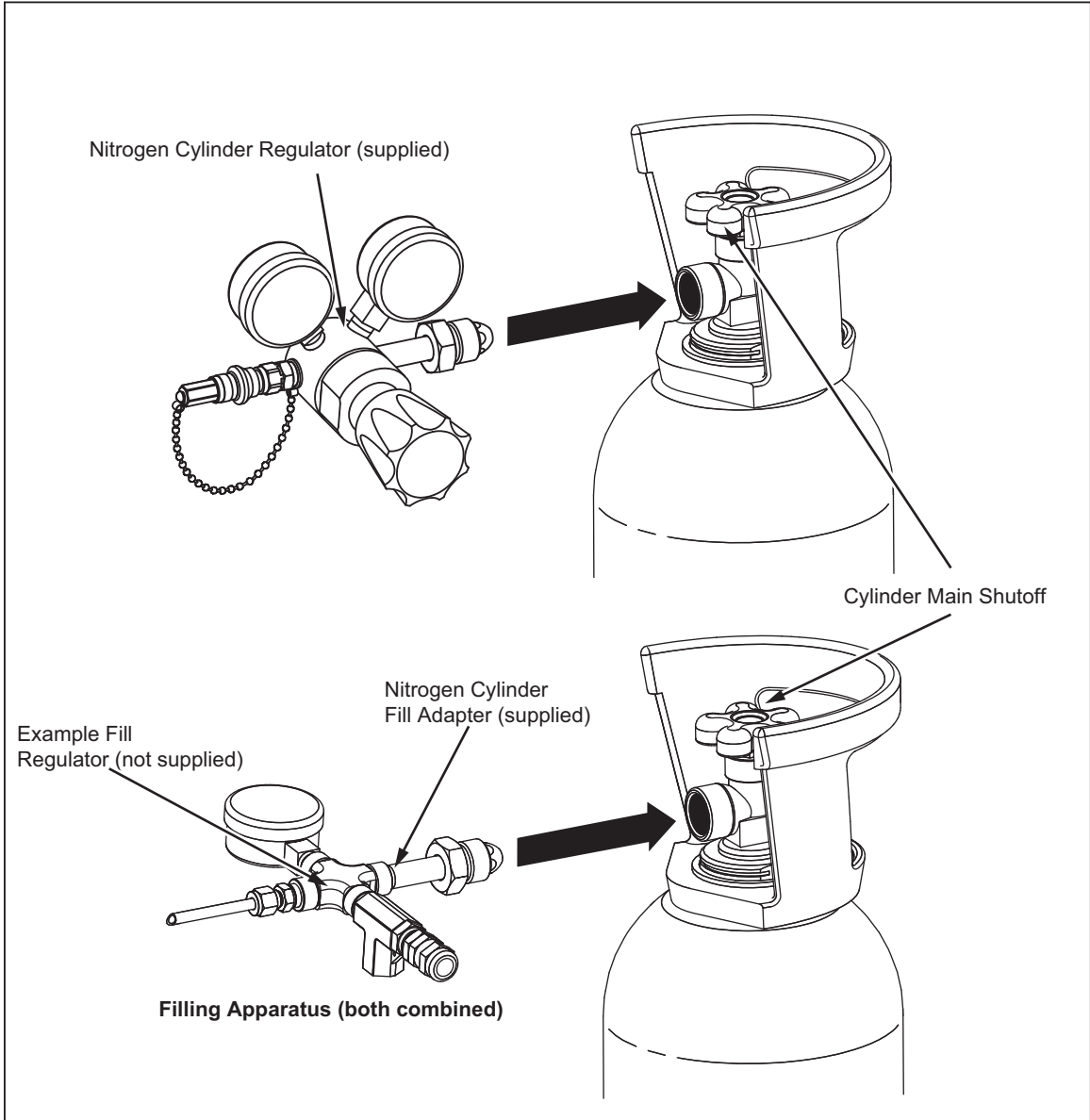

Figure 6-2. Nitrogen Fill Adapter

gxj083.eps

## Controller Troubleshooting

Use the information in the subsequent sections to troubleshoot the Controller.

### Controller Fault Codes

Code Number	Description	Action
01	IEEE port failure	Fault codes 01 and 02 indicates problems with the comm board pca. To clear the fault: <ol style="list-style-type: none"> <li>1. Check the cable that connects to the comm pca to the main pca and try action again.</li> <li>2. Turn off the Controller and disconnect and reconnect the cable connecting the comm pca to the main pca and cycle power.</li> <li>3. Replace the cable that connects to the comm pca to the main pca.</li> <li>4. Replace the cable. Refer to the Service Manual for instructions</li> <li>5. Replace the comm pca. Refer to the Service Manual for instructions</li> </ol>
02	Printer interface failure	
21	Pressure transducer interface failure	Fault codes 21 through 23 indicate problems with the main pca. To clear the fault, reset from on-screen error message and try again. If the reset does not clear the fault, replace the main pca and try again. Refer to the Service Manual for instructions
22	Logic chip failure	
23	User data EEPROM corrupted	
31	User data memory failure	Fault codes 31 through 36 indicate problems with the microprocessor pca. If any of these faults show, there is a problem with the microprocessor pca and it must be replaced to clear the fault. Refer to the Service Manual for instructions
32	Time or date clock failure	
33	User data lost or corrupted	
34	System memory failure	
35	Host interface failure	
36	Internal device interface failure	

Code Number	Description	Action
41	[###] pressure transducer module not responding	Fault codes 41 through 53 indicates problems with the pressure transducer modules, the barometer modules, or the associated pca assemblies. To clear the fault: <ol style="list-style-type: none"> <li>1. Make sure the module is in the correct slot.</li> <li>2. Turn off the Controller. Remove the module and put the module back into the Controller. Make sure the module is fully seated.</li> <li>3. Cycle power.</li> <li>4. If the fault code still shows, replace the associated pca. Refer to the Service Manual for instructions</li> </ol>
42	[###] pressure transducer communication error	
43	[###] pressure transducer module calibration data corrupted	
44	[###] pressure transducer module communication CRC error	
45	[###] pressure transducer module loaded incorrectly	
46	CalCheck Error - [###] pressure transducer module	
47	[###] pressure transducer module address error	
48	[###] pressure transducer module not measuring	
49	[###] pressure transducer module element channel error	
50	[###] pressure transducer module measurement corruption	
51	[###] pressure transducer module measurement out of range	
52	Barometer module not responding	
53	Barometer module calibration data corrupted	
54	Barometer module communication data corruption	

**Electrical Problems**

<b>Problem</b>	<b>Probable Cause</b>	<b>Action</b>
The Controller does not turn on.	Not plugged in. Power not available. Fuse blown. Power module or power circuit board is bad.	Make sure the unit is plugged in and power is available. If the unit is plugged in, use the instructions in this Chapter to check and change the fuse. If the fuses are OK, replace the power module and power supply circuit assembly. Refer to the Service Manual for instructions.
The Controller turns on but then restarts itself non-stop.	Power supply failing. Microprocessor PCB failure. Main PCB failure.	Replace power supply, microprocessor PCB, or main PCB.
Display does not turn on but emits the typical three beeps when powered up.	LCD backlight cable failure. LCD display flat cable failure. LCD module failure.	Reseat LCD backlight cable. Replace LCD backlight cable. Reseat LCD flat cable. Replace LCD flat cable. Replace LCD module.

**Pressure Generation and Indication Problems**

<b>Problem</b>	<b>Probable Cause</b>	<b>Action</b>
Controller cannot reach the target pressure.	No supply. Test port or UUT leaking/open. Supply tube plugged. Internal leak.	<ul style="list-style-type: none"> <li>• Check the supply pressure to make sure supply pressure is available.</li> <li>• Check for leaks around the QC fittings and make sure the hose is not plugged.</li> <li>• If the internal pump is being used and pressure is not reaching the setpoint, the pump seals may be worn and need replacing. Use the instructions in the Service Manual to perform a pump check.</li> </ul>
Controller does not hold pressure at the target pressure.	Test port or UUT leaking/open. Valves require service.	
Pressure does not build when internal motor is selected.	Test port or UUT leaking/open. Internal Leak. Pump requires service.	

***CPS and Quick-Connect Problems***

<b>Problem</b>	<b>Probable Cause</b>	<b>Action</b>
Cannot remove the CPS from the Controller.	System is pressurized. Dock interlock not working correctly.	Vent pressure. Once the CPS is removed, clean or repair the interlock.
Cannot connect the hose to the QC fitting.	Wrong fitting. The QC fitting is worn.	Vent pressure. Once the QC is removed, clean or repair the QC fitting.
QC has a leak.	Seal is damaged or is not fully tightened.	Replace seal. See the Service Manual for instructions.

***Intensifier Troubleshooting***

Use the information in the subsequent sections to troubleshoot the Intensifier.

***Electrical Problems***

<b>Problem</b>	<b>Probable Cause</b>	<b>Action</b>
The Intensifier does not turn on.	Not plugged in. Power not available. Fuse blown. Power module or power circuit board is bad.	Make sure the unit is plugged in and power is available. If the unit is plugged in, use the instructions in this Chapter to check and change the fuse. If the fuses are OK, replace the power module and power supply circuit assembly. Refer to the Service Manual for instructions.



**Pressure Selection and LED Indications**

<b>Problem</b>	<b>Probable Cause</b>	<b>Action</b>
STOP key LED flashing slow.	Supply pressure is below 500 psi.	Increase supply pressure to 500 psi or more. Push <b>STOP</b> to clear the error.
When pressure selection is made, green LED illuminates next to the pressure selection and immediately extinguishes. Then fast flashing red LED next to the <b>STOP</b> key.	Target pressure key pushed with the supply pressure below 500 psi.	Increase supply pressure to 500 psi or more. Push <b>STOP</b> to clear the error.
1,000 key LED flashing	Motor error. The max current was exceeded, possible phase error, other motor controller error.	Double check all motor cables and connections and/or clean the encoder disk surface with a lint free cloth.
2,000 key LED flashing	Invalid value in calibration sequence. The calibration was not updated.	Repeat the adjustment process.
No Intensifier reaction when front-panel key is pushed.	Button, keypad, or front panel ribbon cable is disconnected or damaged.	Make other selections. If other selection works, a single key is bad. Replace the keypad. Refer to the Service Manual for instructions.

**Abnormal Noises**

<b>Problem</b>	<b>Probable Cause</b>	<b>Action</b>
Grinding sound when the motor is turning.	Possible loose or detached bolt in the pump cam assembly.	Immediately push <b>STOP</b> and turn off the unit. Use the procedures in the Service Manual to remove the chassis from the case and inspect for loose hardware.
Hissing sound when unit is off.	Vent Valve may be open. Possible leak in the quick-connect fitting. Possible worn seal in the main pressure shaft. Possible leak in an internal pressure supply line.	Close the Vent Valve. If sound persists, close Isolation Valve. If sound stops then check tubing and outlet QC. If sound persists then replace pressure port and piston seals.
Loud, periodic pressure relief sound ("blow by") when the motor is turning accompanied by slower pressure generation.	Possible worn or damaged piston seal.	Replace the piston seals on all four pistons. Refer to the Service Manual for instructions.
Loud internal pressure relief sound before 10,000 psi accompanied by a rapid pressure decrease.	The internal pressure relief valve is discharging prematurely.	Replace the valve. Refer to the Service Manual for instructions.

### Pressure Generation and Indication Problems

Problem	Probable Cause	Action
Pressure generation is slow but <b>does</b> build to pressure selection.	Possible worn piston seals.	If generation takes more than 4 minutes to reach set pressure or if pressure generation is erratic (above and below set pressure) then replace seals.
Pressure generation is slow and <b>does not</b> build to pressure selection.	Worn piston seals.	Replace piston seals.
Pressure gauge shows spikes in pressure generation.	Possible worn springs in ICM or worn piston seal.	If spikes are excessive (above and below set pressure) then replace piston seals.
Pressure gauge does not match selection after motor stops and keeps pressure stable.	Gauge can be inaccurate. Pressure sensor needs to be calibrated.	When pressure is stable gauge should read pressure 5 % to 8% above set pressure. If this amount is more than 10 % off or if generated pressure is below set pressure, realign the pressure sensor.

### Valves and Quick-Connect Problems

Problem	Probable Cause	Action
Cannot fully close or open the isolation or vent valve.	Valve is damaged.	Replace the Vent or Isolation Valve. Refer to the Service Manual for instructions.
Cannot connect the hose to the QC fitting.	Wrong fitting. The QC fitting is damaged.	Try another hose end to connect to the QC fitting. If this also cannot be connected and if the plug is not in the QC, then the QC fitting is damaged and must be replaced. Refer to the Service Manual for instructions.
QC has a leak.	Fitting is not inserted correctly. Seal is damaged.	A leak in the quick connect should be checked with a plug in the QC to rule out the hose connection. If the QC has a leak it must be rebuilt with new seals.
Cannot disconnect hose from QC.	There is pressure in the hose	Turn off Nitrogen Cylinder regulator and vent hose.

# Chapter 7

## Self-Calibration Procedure

Title	Page
Introduction.....	7-3
Fundamentals.....	7-3
Required Equipment.....	7-4
Environmental Conditions.....	7-4
Equipment Setup.....	7-5
Preliminary Operations.....	7-5
Module Calibration Procedure.....	7-7
Module Alignment Procedure.....	7-9



## Introduction

This chapter supplies information and instructions on how to calibrate and align the G70M, G10M, G700K, A150K, and barometer modules in the Controller.

### Note

*This chapter does not contain information on the Intensifier because the Intensifier does not require a calibration procedure. If the pressure transducer in the Intensifier needs adjusted, use the adjustment procedure in the 4322 Service Manual.*

## Fundamentals

Pressure transducer modules (the modules) are removable and interchangeable without effect on their measurement performance or calibration. Calibration data required for the reliable operation of the modules is stored onboard a memory chip inside of each module. This data is retained even if the module is inserted in a different Controller. Though it is not recommended, the coefficients can be manually adjusted in View/Edit Calibration menu.

Calibration is performed with the automated self-calibration function that is a feature of the Controller. When the calibration is finished, the Controller compares the measurements made by the modules to the external reference pressure standard. The Controller then displays the pass or fail information for the modules tested. If the modules fail the calibration, then the modules must be adjusted.

### Caution

**To prevent damage to the product, only personnel that are qualified should calibrate the product.**

The calibration process has two test types: Calibration and Alignment. Calibration is a performance verification procedure that tests to see if the module is within tolerance. Alignment is a performance verification procedure as well, but lets the operator automatically apply calculated calibration coefficients to bring the module into tolerance. This is done by “activating” the changes after the Alignment procedure is complete.

## Required Equipment

The equipment in Table 7-1 is required to complete the calibration procedure.

**Table 7-1. Calibration Equipment**

Primary Reference		
Classifications	Minimum Use Specifications	Suggested Equipment
Automated Pressure Calibrator (APC)	See Required Components	Supplied with Fluke 4322
Pressure Controller	Range: 0.5 psia to 10,000 psia (-14.2 to 10,000 psig) Fluke 4322 required	Supplied with Fluke 4322
CPS module (Contamination Prevention System)	Clean and dry.	Supplied with Fluke 4322
Cylinder hose	10,000 psi, Fluke 4322 QC stem	Supplied with Fluke 4322
Intensifier outlet hose	10,000 psi, Fluke 4322 QC stem	Supplied with Fluke 4322
Test hose	10,000 psi, Fluke 4322 QC stem, King Nutronics QC stem	Supplied with Fluke 4322
Reference pressure standard	Gauge pressure: 0 to 4 psig: $\pm 0.001$ psi 4 to 10,000 psig: $\pm 0.025$ % of reading  Vacuum Pressure: 0 to 30 inHg: $\pm 0.025$ % of reading or $\pm 0.002$ in-Hg, whichever is greater  Absolute Pressure: 0.5 to 35 inHga: $\pm 0.002$ inHg 17.2 to 10,000 psia: $\pm 0.025$ % of reading	King Nutronics 3689 or equivalent
Nitrogen Supply	Clean, dry, minimum 500 psig	Nitrogen Cylinder
IEEE cable	Standard: IEEE-488.2 Minimum length: 2 ft	Supplied with Fluke 4322

## Environmental Conditions

Laboratory environmental conditions required to complete this procedure:

- Ambient temperature range: 60 °F to 85 °F. Must not change more than  $\pm 4$  °F throughout the calibration.
- Ambient relative humidity: 5 % to 95 %. Must not change more than  $\pm 20$  % RH throughout the calibration.
- Low wind and draft area.

## Equipment Setup

The operator can choose to calibrate all installed modules or only selected ranges. Pressure supply sufficient to reach the selected modules' maximum pressure must be connected. For example, to calibrate the G10M (1500 psig) module, a gas cylinder with approximately 2000 psi should be used. To calibrate the G70M (10,000 psi) module, the 4322 intensifier must be used.

### Note

*The supply must be disconnected in order to calibrate the barometer module and the A150K module.*

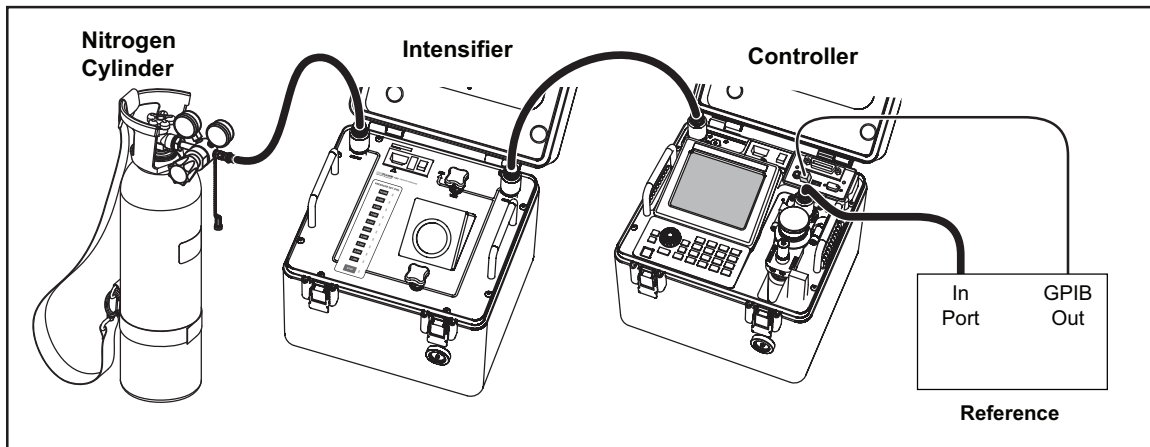

Figure 7-1. Equipment Setup

gxj086.eps

## Preliminary Operations

Prepare for the calibration procedure as follows:

1. Turn on the 4322 Pressure Controller (the Controller) and let it warm up for at least 1 hour.
2. Turn on the reference pressure standard and let it warm up for at least 1 hour.
3. Connect the Nitrogen Cylinder supply to the Controller as follows (see Figure 7-1):

### Note

*Do not connect the supply to the Controller when calibrating the barometer module and the A150K module. For all other modules, make sure the supply is connected*

- a. Make sure the Nitrogen Cylinder pressure is more than 500 psig and no more than 2000 psig.

### **⚠ Warning**

**To prevent injury or possible death, do not over pressurize the Nitrogen Cylinder. Maximum pressure of the Cylinder is 2000 psig.**

- b. Connect the male end of the regulator hose to the Nitrogen Cylinder regulator port.
- c. Connect the other end of the regulator hose to the female SUPPLY QC port on the Intensifier.

*Note*

*Close the Nitrogen Cylinder regulator when the Intensifier is not in use.*

4. Connect the Intensifier to the Controller as follows (see Figure 7-1):
  - a. Connect the two male ends of the system interconnect hose to the OUTPUT port on the Intensifier and the SUPPLY port on the Controller.
  - b. On the Intensifier, make sure the VENT valve is closed and the ISOLATION valve is full open.
  - c. Fully open the Nitrogen Cylinder and regulator to supply pressure to the Intensifier.
5. Put a clean, dry CPS into the Controller.
6. Connect the Controller to the reference pressure standard as follows:
  - a. Connect the male end of the test hose to the TEST port on the CPS in the Controller.
  - b. Connect the female end of the test hose to the TEST port on the reference pressure standard.

*Note*

*For connection to the reference pressure standard, a male QC union must be assembled to connect the female test hose QC to the female QC on the KN 3689. This union will have one of the male IQC70 QCs on one end and a King Nutronics male QC stem on the other end.*

- c. Connect the Controller IEEE interface to the reference pressure standard IEEE interface with an IEEE 488.2 cable.
7. Turn on the Intensifier.
8. On the Intensifier, set the required boost pressure.
9. Set up communication between the Controller and the KN 3689 as follows:
  - a. On the KN 3689, select option **2** to select **COMPUTER CONTROL**.
  - b. After selection, the display reads: **ENTER IEEE ADDRESS**. Type in **10** and push **ENTER**.
  - c. Push down the VENT knob on the KN 3689 to zero the reading. The display reads: **SYSTEM VENTING** while the zeroing is in progress.
  - d. When venting is complete, the display reads: **PULL UP VENT KNOB**. After this message is shown, pull up the VENT knob on the KN 3689 and confirm the reading shows: **.000 PSIG**.



## Module Calibration Procedure

This procedure supplies instructions on how to perform the Calibration procedure on the G70M, G10M, G700K, A150K, and barometer modules. As mentioned in the Fundamentals section, Calibration is a performance verification procedure that tests to see if the module is within tolerance. No changes to the coefficients can be made with the Calibration procedure. After the Calibration procedure is complete, an Alignment should be completed if any of the modules did not pass the calibration.

1. Select the **Advanced Operating** mode on the startup screen.
2. Select **Settings**.
3. Select **Calibration** to edit the Calibration menu.
4. Select **Run Calibration**.
5. Select the desired module as shown in Figure 7-2.



Figure 7-2. Module Selection

hbx067.jpg

6. Fill in the Run Calibration menu as follows (see Figure 7-3):

*Note*

*Text enclosed in [brackets] denotes a custom user entry.*

- a. Test type: **Gauge Calibration or Abs Calibration**
- b. Adjustment Tol %: [user entry]

*Note*

*Adjustment Tol % will be disabled if Use Tol is set to No.*

- c. Use Tol: **Yes** to use the Adjustment tol % from the last step or **No**
- d. Head Relative to 4322: **0** if on the same surface. If not, measure the head-height difference and enter it into the field. Use a positive (+) value if the Reference is above the Controller and a negative (-) value if the Reference is below.
- e. Reference SN: [serial number of the KN 3689]
- f. Addr: **10**
- g. Time/Date: [automatically populated]
- h. Operator: [enter initials]

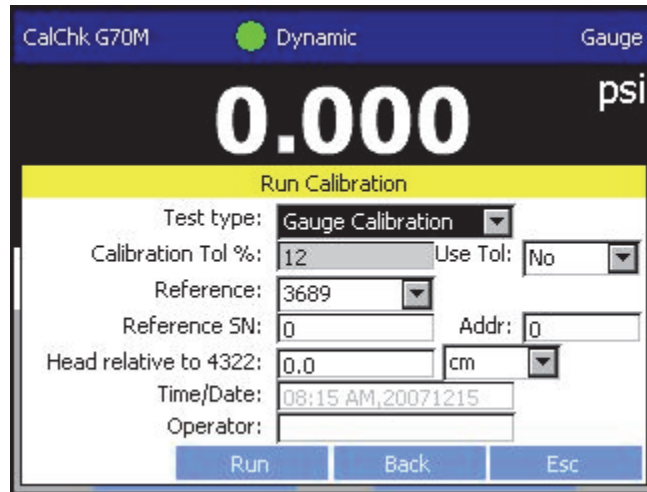

hbx070.jpg

**Figure 7-3. Calibration Menu Configuration**

7. Select **Run**. This starts the calibration procedure.

The Calibration procedure is an automated process. The Controller automatically sets pressure, dwells, and takes measurements. As the test runs, the Controller reads the measurements from the modules and receives measurements data from the KN 3689 over the GPIB connection. The measurements are compared by the Controller. When the calibration procedure is complete, a table with data and pass/fail information is displayed on the screen. After the pass/fail information is shown on the screen, a new screen appears that shows the deviation calculations.

## Module Alignment Procedure

This procedure supplies instructions on how to perform the alignment procedure on the G70M, G10M, G700K, A150K, and barometer modules. As mentioned in the Fundamentals section, Alignment is a performance verification procedure that tests to see if the module is within tolerance. If it is out of tolerance, the deviation is automatically calculated and shown on the screen at the end of the test. At this time, the operator can “activate” the corrections to bring the module back into tolerance.

1. Select the **Advanced Operating** mode on the startup screen.
2. Select **Settings**.
3. Select **Calibration** to edit the Calibration menu.
4. Select **Run Calibration**.
5. Select the desired module as shown in Figure 7-4.

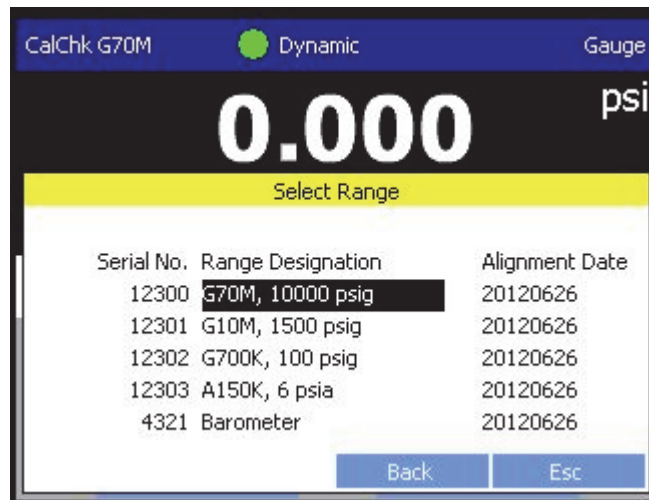

Figure 7-4. Module Selection

hbx067.jpg

6. Fill in the Run Calibration menu as follows (see Figure 7-5):

*Note*

*Text enclosed in [brackets] denotes a custom user entry.*

- a. Test type: **Alignment**
- b. Adjustment Tol %: *[user entry]*
- c. Use Tol: **Yes** to use the Adjustment tol % from the last step or **No**
- d. Head Relative to 4322: **0** if on the same surface. If not, measure the head-height difference and enter it into the field. Use a positive (+) value if the UUT is above the Controller and a negative (-) value if the UUT is below.
- e. Reference SN: *[serial number of the KN 3689]*
- f. Addr: **10**
- g. Time/Date: *[automatically populated]*
- h. Operator: *[enter initials]*

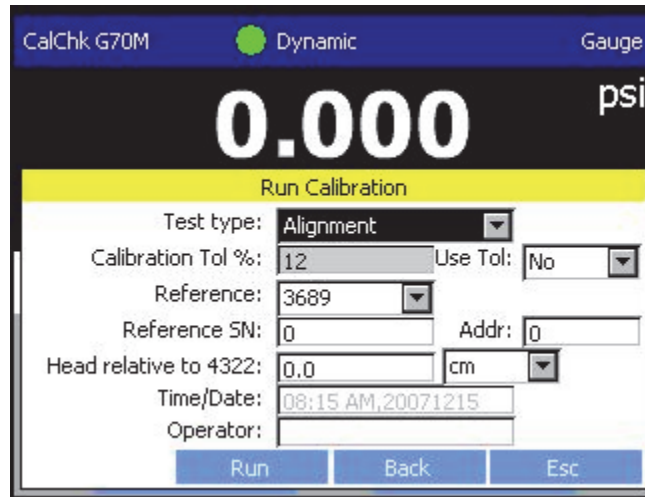

hbx068.jpg

Figure 7-5. Alignment Menu Configuration

7. Select **Run**. This starts the Alignment procedure.

The Alignment procedure is an automated process. The Controller automatically sets pressure, dwells, and takes measurements. As the test runs, the Controller reads the measurements from the modules and receives measurements data from the KN 3689 over the GPIB connection. The measurements are compared by the Controller. When the Alignment procedure is complete, a new screen will appear that shows the test results with deviation calculations. To finalize the Alignment, select “Activate” on the bottom of the menu to save the new coefficients to the module. The Alignment procedure is now complete. Calibration should be performed to verify that the aligned range meets measurement tolerances.

# Appendix A

## Example Tests

### Introduction

This chapter contains two basic test procedures (pressure gauge and switch) to help the user become familiar with how to run a test.

### Example Gauge Calibration Procedure (Normal Mode)

This section contains an example procedure to calibrate a 500 psi gauge in the Normal Operating mode. If a 500 psi gauge is not available, the test can be edited to a lower.

Configure the Calibrator and the UUT:

1. Connect the Nitrogen Cylinder to the Intensifier then connect the Intensifier to the Controller. (see “Configure the Pressure Supply” in Chapter 2).
2. Prepare the UUT for calibration (see “Connect to a UUT” Chapter 2).
3. Turn on the Controller and Intensifier.
4. Open the Isolation Valve and close the Vent Valve on the Intensifier.
5. Push  on the Intensifier to set a boost pressure of 1000 psig.

Set up the Automated Gauge Test as follows:

1. Select the Normal Operation mode on the Startup menu as shown below.

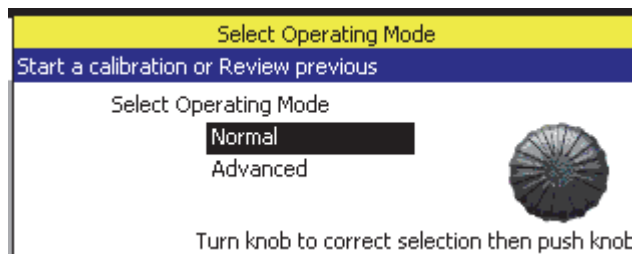

2. Select Calibrate UUT as shown below.

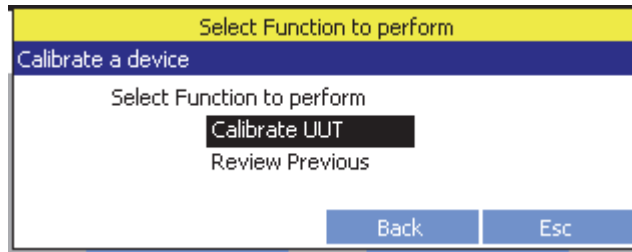

3. Select Pressure Gauge in the Select UUT Type as shown below.

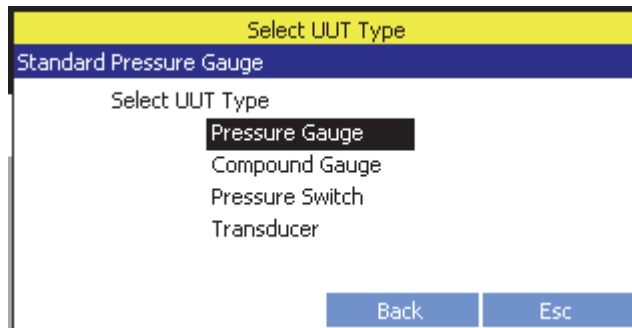

4. Key **5 0 0** into Pressure Full Scale field, key **0 . 0 1** into the UUT Tolerance field, and set the mode to **Gauge** as shown below. Push **OK** to continue.

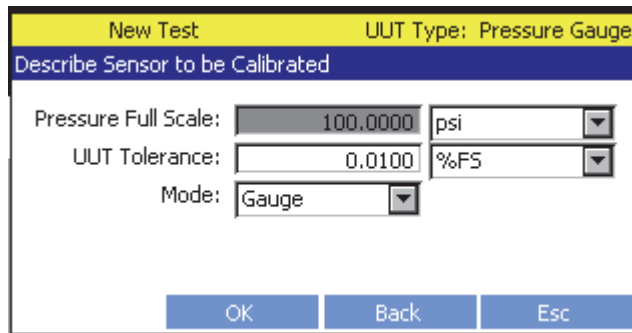

5. Select **Auto Fill** to add a series of test points. Once the Auto Fill menu is open, key in **5 0 0** into the Max field. Push **Add** to Auto Fill the points and push **OK** to return to the Edit Test menu. The menu should now look like the image below. Push **OK** to continue.

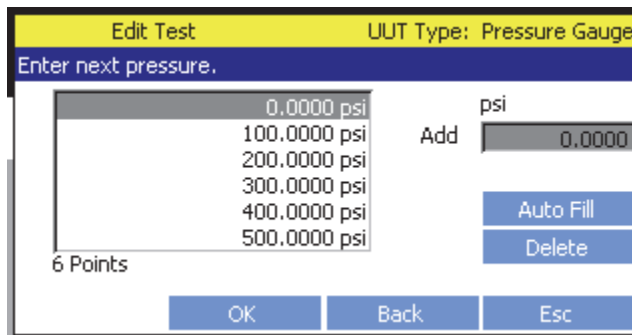

6. Select the Static mode as shown below.

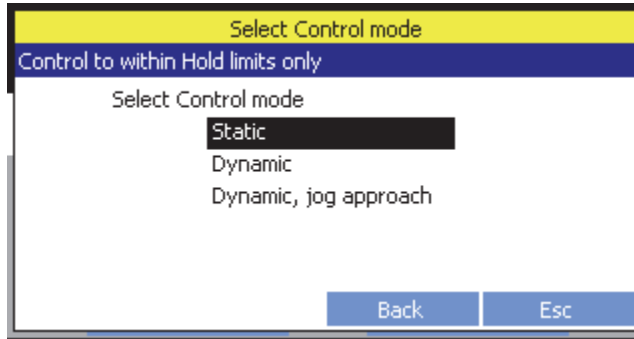

7. Select **Test** on the Main menu to open the Run Test menu.

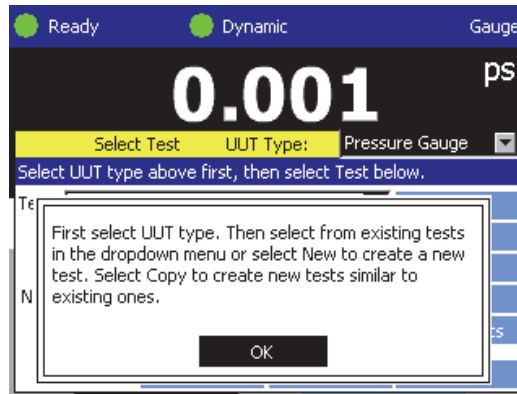

8. Choose **Pressure Gauge, Compound Gauge, or Transducer** from the UUT Type drop-down box.
9. Find and select the test named **“5 Points, 0 to 500 psi g”** from the Test drop-down box.

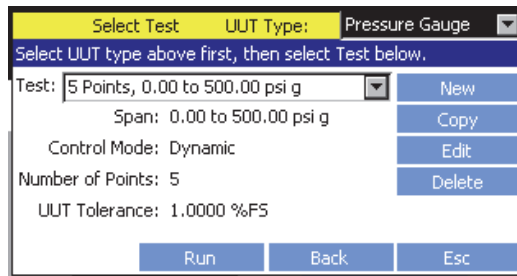

10. Select **Run** to continue to the UUT information menu.
11. Key **4 5 3 4 7** (45347) into the UUT Serial No. field then select **OK**.
12. Use the rotary dial to input **“Example”** into the UUT Manufacturer field then select **OK**.
13. Key **1 7 0 0** (1700) into the UUT Model field then select **OK**.
14. Use the rotary dial to input **“JD”** into the Operator field then select **OK**.

15. Key in **7 0 . 9** (70.9) into the Ambient Temp field then select **OK**.

Run Test		UUT Type: Pressure Gauge	
Populate information for this test. Conduct any pre-test function:			
UUT Serial No.:	45347		
UUT Manufacturer:	EXAMPLE	Hose Purge	
UUT Model:	1700	System Purge	
Time/Date:	08:15 AM, 20071215	Leak Test	
Operator:	JD	Exercise	
Ambient Temp.:	70.9	deg F	
Run Local		Run Handheld	
Back		Esc	

16. Select **Run Local** or **Run Handheld** to continue.

**Run the Test Sequence as follows:**

1. Select **Start** to run the test when ready. Since the first test point is 0 (1/5 0.00 psi), the Controller vents to atmosphere and then displays the **Ready** indicator. Push **MEASURE SELECT** then key in the UUT value of **0** (0).

Run Test	
Setting target	
Point:	1/5 0.00 psi
UUT value:	0.0000 OUT OF TOL
Reference value:	0.0000
Back	
Esc	

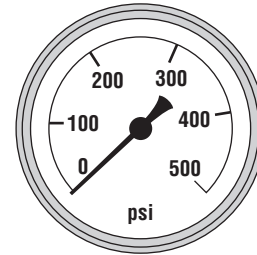

2. Select **Next Point**. The Controller controls pressure to the second test point (2/5 125.00 psi). After pressure is stable, the Controller displays the **Ready** indicator. Push **MEASURE SELECT** then key in the UUT value of **1 2 5** (125).

Run Test	
Setting target	
Point:	2/5 125.00 psi
UUT value:	0.0000 OUT OF TOL
Reference value:	0.0000
Back	
Esc	

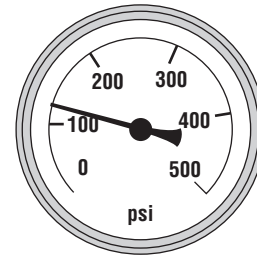



3. Select **Next Point**. The Controller controls pressure to the second test point (3/5 250.00 psi). After pressure is stable, the Controller displays the **Ready** indicator. Push **MEASURE SELECT** then key in the UUT value of **2 5 1** (251).

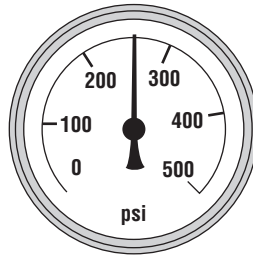
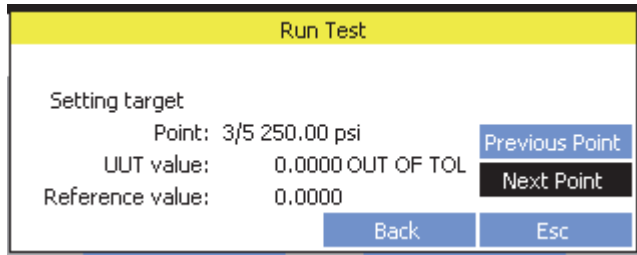

4. Select **Next Point**. The Controller controls pressure to the second test point (4/5 375.00 psi). After pressure is stable, the Controller displays the **Ready** indicator. Push **MEASURE SELECT** then key in the UUT value of **3 7 6** (376).

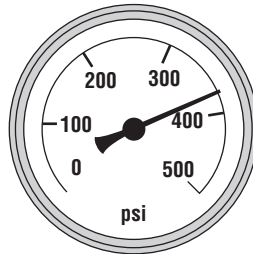
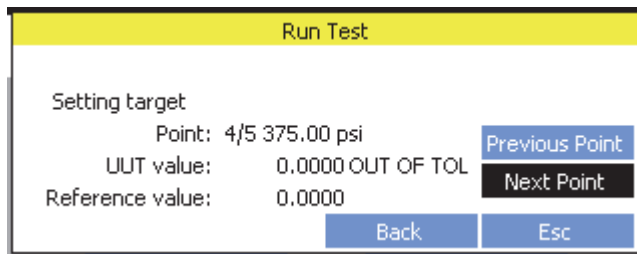

5. Select **Next Point**. The Controller controls pressure to the second test point (5/5 500.00 psi). After pressure is stable, the Controller displays the **Ready** indicator. Push **MEASURE SELECT** then key in the UUT value of **5 0 2** (502).

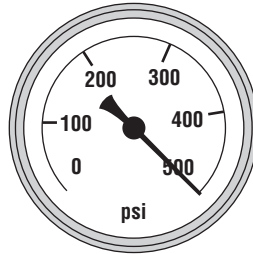
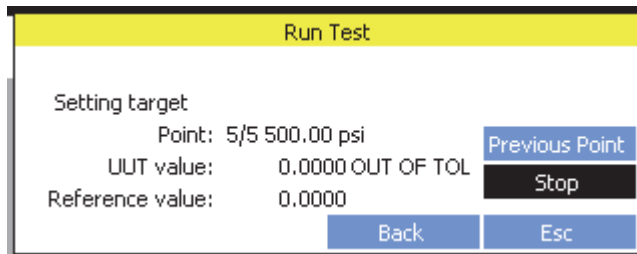

6. Select **Stop** to open the Test Results menu.

Test Results		
Test Point	Deviation	
1) 0.00000 psi	0.00000 psi	0.00 %FS Fail
2) 125.0000 psi	0.00000 psi	0.00 %FS Fail
3) 250.0000 psi	0.00000 psi	0.00 %FS Fail
4) 375.0000 psi	0.00000 psi	0.00 %FS Fail
5) 500.0000 psi	0.00000 psi	0.00 %FS Fail

7. Select **Print** to print the a report, **Repeat Test** to do the test over, or **New Test** to make a new test with the parameters in this test.

## Example Pressure Switch Calibration Procedure

This section contains an example pressure switch calibration procedure. Use this section to become familiar with the calibration procedure and also as a reference.

This procedure is to calibrate a 500 psi switch. If a 500 psi switch is not available, the test can be edited to a lower pressure (see “Edit a Test” on page 1-**Error! Bookmark not defined.**).

Configure the Calibrator and the UUT:

1. Connect the Nitrogen Cylinder to the Intensifier then connect the Intensifier to the Controller. (see “Pressure Supply Configuration” on page 1-**Error! Bookmark not defined.**).
2. Prepare the UUT for calibration (see “UUT Configuration” on page 1-**Error! Bookmark not defined.**).
3. Turn on the Controller and Intensifier.
4. Open the Isolation Valve and close the Vent Valve on the Intensifier.
5. Push **1,000** on the Intensifier to set a boost pressure of 1000 psi.
6. Connect the Handheld to the switch as shown in Figure **Error! Reference source not found.** on page 1-**Error! Bookmark not defined.**.

Set up the Automated Gauge Test as follows:

1. Select **Test** on the Main menu to open the Run Test menu.

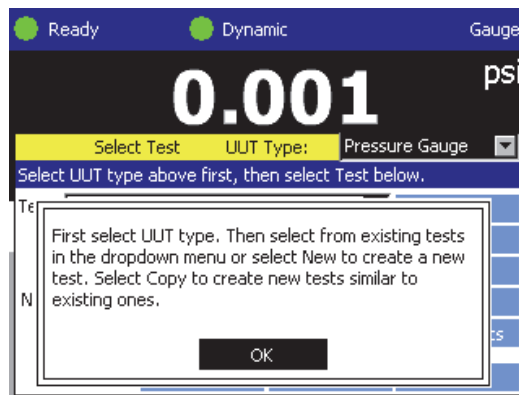

2. Select **Pressure Switch** from the UUT Type drop-down box.
3. Find and select the test named “**Switch 104/74 psi g**” from the Test drop-down box.

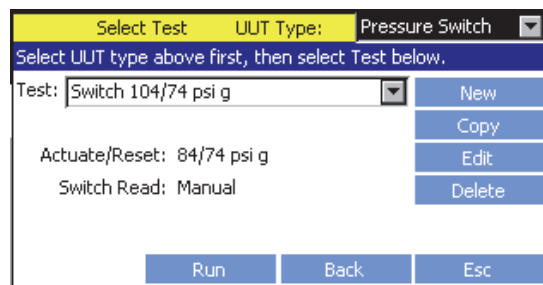

1. Select **Run** to continue to the UUT information menu.
2. Key **4 5 3 4 7** (45347) into in the UUT Serial No. field then select

3. Use the rotary dial to input “**Example**” into the UUT Manufacturer field then select **OK**.
4. Key **1 7 0 0** (1700) into the UUT Model field then select **OK**.
5. Use the rotary dial to input “**RLM**” into the Operator field then select **OK**.
6. Key **7 0 . 9** (70.9) into the Ambient Temp field then select **OK**.

Run Test		UUT Type: Pressure Switch	
Populate information. Conduct pre-test functions. Select Run.			
UUT Serial No.:	45347		
UUT Manufacturer:	EXAMPLE	Hose Purge	
UUT Model:	1700	System Purge	
Time/Date:	08:15 AM, 20071215	Leak Test	
Operator:	RLM	Exercise	
Ambient Temp.:	70.9	deg F	
Run Local	Run Handheld	Back	Esc

7. Select **Run Local** or **Run Handheld** to continue.

*Note*

*For pressure switch Test Sequences, **Run Handheld** does not have to be selected to use the continuity check feature on the Handheld Control. To use the continuity check function, connect the Handheld Control to the Controller then select **Run Local**. In both modes, the Handheld Control automatically senses continuity changes if the pressure switch test parameter “Switch Read” is set to “Automatic”. If set to “manual”, the user keys in the pressure when the continuity changes.*

**Run the Test Sequence as follows:**

1. Select **Start** to run the test when ready. The Controller starts to control pressure to the upper-lower limit set in the Test Sequence parameters. As it approaches the limit, the pressure stabilizes and the Controller prompts the user to Jog pressure up to the expected cutout pressure. If the Continuity sensing was set to “Manual”, push **MEASURE SELECT** then key in the UUT value at which the continuity switches. Key in **9 8 . 7** (98.7). If the Continuity sensing was set to “Automatic” the pressure at which the continuity switch is automatically recorded.

Run Test	
Setting target	
Point: Up scale	
Test limits: 94 to 104 psi	
Actuation:	
Use knob or arrows to jog pressure	

2. Select **Next Point**. The Controller starts to control pressure to the lower-upper limit set in the Test Sequence parameters. As it approaches the limit, the pressure stabilizes and the Controller prompts the user to Jog pressure down to the expected cutout pressure. If the Continuity sensing was set to “Manual”, push **MEASURE SELECT** then key in the UUT value at which the continuity switches. Key in **8 9 . 7** (89.7). If the Continuity sensing was set to “Automatic” the pressure at which the continuity switch is automatically recorded.

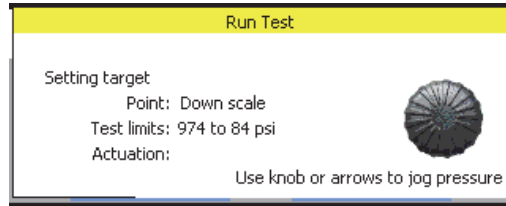

3. Select **Stop** to open the Test Results menu.

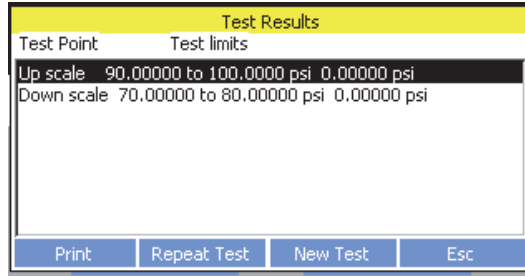

4. Select **Print** to print the a report, **Repeat Test** to do the test over, or **New Test** to make a new test with the parameters in this test.